

OPERATION & MAINTENANCE

PREMIUM Q

60HZ

GEO SMART ENERGY

OMW5-0017S



 **WARNING**



WARNING: Before performing service or maintenance operations on the system, turn off main power switches to the unit. Electrical shock could cause serious personal injury.

WARNING: All products are designed, tested, and manufactured to comply with the latest publicly released and available edition of UL 60335-2-40 for electrical safety certification. All field electrical connections must follow the National Electrical Code (NEC) guide standards and / or any local codes that may be applicable for the installation.

WARNING: Only factory authorized personnel are approved for startup, check test and commissioning of this unit.

INSTALLER: Please take the time to read and understand these instructions prior to any installation. Installer must give a copy of this manual to the owner.

Definition of Warnings and Symbols

 DANGER	Indicates a situation that results in death or serious injury.
 WARNING	Indicates a situation that could result in death or serious injury.
 CAUTION	Indicates a situation that could result in minor or moderate injury.
NOTICE	Indicates a situation that could result in equipment or property damage.

For the User

 **WARNING**

This appliance is not intended for use by persons (including children) with reduced physical, sensory, or mental capabilities, or lack of experience and knowledge, unless they have been given supervision or instruction concerning use of the appliance by a person responsible for their safety.

Children should be supervised to ensure that they do not play with the appliance.

Keep this manual in a safe place in order to provide your service personnel with necessary information.

NOTICE

NOTICE: To avoid equipment damage, do not leave the system filled in a building without heat during cold weather, unless adequate freeze protection levels of antifreeze are used. Heat exchangers do not fully drain and will freeze unless protected, causing permanent damage.

Table of Contents

UNIT OVERVIEW

General Installation Information 4
 Nomenclatures 6
 AHRI Data 7
 Physical Data 9
 Dimensional Data 10

OPERATING PRINCIPLES

Electrical Data 11
 Auxiliary Heat Ratings 12
 Auxiliary Heat Electrical Data 12
 Blower Performance Data 13
 Antifreeze Corrections 15
 Correction Factor Tables 16
 Heat of Extraction/Heat of Rejection 17
 Water Quality 18
 Operating Parameters 19
 Pressure Drop 20
 Operation Logic Data Table 21
 Aurora Controls Operation 22
 Refrigerant Circuit Guideline 35
 Electrical Information 36
 Electronic Thermostat Installation 38
 Electrical Information Flow Centers 39

SERVICE AND TROUBLESHOOTING

Closed Loop Ground Source Systems 40
 Open Loop Ground Water Systems 41
 Compressor and Thermistor Resistance 42
 Reference Calculations and Legend 43
 Preventative Maintenance 43
 Replacement Procedures 44
 Troubleshooting 44
 Aurora Interface Diagnostic (AID) Tool 46
 Preliminary Checkout Procedure 46
 Control Board Troubleshooting Steps 47
 Control Board Troubleshooting Flow Charts 49
 Communicating Thermostat Troubleshooting Guide 61
 Control Board Signals 63
 Jumping the Control Board 66
 Water Side Analysis: Heat of Extraction/Rejection 69
 Superheat/Subcooling 70
 Troubleshooting Forms 72
 Performance Data 75
 Service Parts Table 87
 Decommissioning 88
 Decommissioning - Unit Labeling Requirements 88
 Refrigerant Recovery 89
 Refrigerant Removal and Evacuation 89
 Charging Procedures 90

REVISION GUIDE

. 91

General Installation Information

NOTICE: Do not store or install units in corrosive environments or in locations subject to temperature or humidity extremes. Corrosive conditions and high temperature or humidity can significantly reduce performance, reliability, and service life.

NOTICE: A minimum of 24 in. clearance should be allowed for access to front access panel.

NOTICE: To avoid equipment damage, DO NOT use these units as a source of heating or cooling during the construction process. The mechanical components and filters can quickly become clogged with construction dirt and debris, which may cause system damage and void product warranty.

For the Installer

If you are NOT sure how to install or operate the unit, contact your dealer.

Installing and servicing air conditioning and heating equipment can be hazardous due to system pressure and electrical components. Only trained and qualified service personnel should install, repair or service heating and air conditioning equipment. When working on heating and air conditioning equipment, observe precautions in the literature, tags and labels attached to the unit and other safety precautions that may apply.

This manual contains specific information about the required qualification of the working personnel for maintenance, service and repair operations. Every working procedure that affects safety means shall only be carried out by competent persons.

Examples for such working procedures are:

- breaking into the refrigerating circuit;
- opening of sealed components or ventilated enclosures.

Follow all safety codes. Wear safety glasses and work gloves. Use quenching cloth for brazing operations. Have fire extinguisher available for all brazing operations. Follow all procedures to remain in compliance with national gas regulations.

Prior to beginning work on systems containing FLAMMABLE REFRIGERANTS, safety checks are necessary to ensure that the risk of ignition is minimized. Work shall be undertaken under a controlled procedure so as to minimise the risk of a flammable gas or vapor being present while the work is being performed. All maintenance staff and others working in the local area shall be instructed on the nature of work being carried out. Work in confined spaces shall be avoided.

The area shall be checked with an appropriate refrigerant detector prior to and during work, to ensure the technician is aware of potentially toxic or flammable atmospheres. Ensure that the leak detection equipment being used is suitable for use with all applicable refrigerants, i.e. non-sparking, adequately sealed or intrinsically safe.

If any hot work is to be conducted on the refrigerating equipment or any associated parts, appropriate fire extinguishing equipment shall be available to hand. Have a dry powder or CO2 fire extinguisher adjacent to the charging area.

No person carrying out work in relation to a REFRIGERATING SYSTEM which involves exposing any pipe work shall use any sources of ignition in such a manner that it may lead to the risk of fire or explosion. All possible ignition sources, including cigarette smoking, should be kept sufficiently far away from the site of installation, repairing, removing and disposal, during which refrigerant can possibly be released to the surrounding space. Prior to work taking place, the area around the equipment is to be surveyed to make sure that there are no flammable hazards or ignition risks. "No Smoking" signs shall be displayed.

Where electrical components are being changed, they shall be fit for the purpose and to the correct specification. At all times the manufacturer's maintenance and service guidelines shall be followed. If in doubt, consult the manufacturer's technical department for assistance.

The following checks shall be applied to installations using FLAMMABLE REFRIGERANTS:

- the actual REFRIGERANT CHARGE is in accordance with the room size within which the refrigerant containing parts are installed;
- the ventilation machinery and outlets are operating adequately and are not obstructed;
- if an indirect refrigerating circuit is being used, the secondary circuit shall be checked for the presence of refrigerant;
- marking to the equipment continues to be visible and legible. Markings and signs that are illegible shall be corrected;
- refrigerating pipe or components are installed in a position where they are unlikely to be exposed to any substance which may corrode refrigerant containing components, unless the components are constructed of materials which are inherently resistant to being corroded or are suitably protected against being so corroded.

Instructions for Equipment Using R-454B Refrigerant

WARNING

- **Do NOT pierce or burn**
- **Do NOT use means to accelerate the defrosting process or to clean the equipment, other than those recommended by the manufacturer**
- **Be aware that refrigerants may not contain an odor**

WARNING

- **The Appliance should be stored so as to prevent mechanical damage and in a room without continuously operating ignition sources (example: open flames, an operating gas appliance or an operating electric heater)**

General Installation Information

WARNING

Ventilated Area: ensure that the area is in the open or that it is adequately ventilated before breaking into the system of conducting any hot work. A degree of ventilation should continue during the period that the work is carried out. The ventilation should safely disperse any released refrigerant and preferably expel it. Keep ventilation area clear of obstructions!

WARNING

Do NOT use potential sources of ignition in searching for or detection of refrigerant leaks. A halide torch (or any other detector using a naked flame) shall not be used.

The following leak detection methods are deemed acceptable for all refrigerant systems. Electronic leak detectors may be used to detect refrigerant leaks but, in the case of FLAMMABLE REFRIGERANTS, the sensitivity may not be adequate, or may need re-calibration. (Detection equipment shall be calibrated in a refrigerant-free area.) Ensure that the detector is not a potential source of ignition and is suitable for the refrigerant used. Leak detection equipment shall be set at a percentage of the LFL. of the refrigerant and shall be calibrated to the refrigerant employed, and the appropriate percentage of gas (25 % maximum) is confirmed. Leak detection fluids are also suitable for use with most refrigerants but the use of detergents containing chlorine shall be avoided as the chlorine may react with the refrigerant and corrode the copper pipe-work. NOTE Examples of leak detection fluids are bubble method, fluorescent method agents If a leak is suspected, all naked flames shall be removed/extinguished. If a leakage of refrigerant is found which requires brazing, all of the refrigerant shall be recovered from the system, or isolated (by means of shut off valves) in a part of the system remote from the leak. Removal of refrigerant shall follow the procedure outlined in this manual.

Installation Site

This equipment has been evaluated to be installed up to a maximum altitude of 3000m (9843ft) and should not be installed at an altitude greater than 3000m. For installation only in locations not accessible to the general public.

WARNING

For appliances using A2L refrigerants connected via an air duct system to one or more rooms, only auxiliary devices approved by the appliance manufacturer or declared suitable with the refrigerant shall be installed in connecting ductwork. The manufacturer shall list in the instructions all approved auxiliary devices by manufacturer and model number for use with the specific appliance, if those devices have a potential to become an ignition source.

Installation Space Requirements

NOTE: Equipment with refrigerant charge less than 62 oz does not require have a minimum floor area requirement and does not require a refrigerant leak detection sensor. The sensor might be added as a feature.

WARNING

Equipment containing R-454B refrigerant shall be installed, operated, and stored in a room with floor area larger than the area defined in the “Minimum Floor Area” chart based on the total refrigerant charge in the system. This requirement applies to indoor equipment with or without a factory refrigerant leakage sensor.

CAUTION

It is not recommended to use a potable water source for this equipment water supply.

WARNING

This equipment comes with a factory installed Refrigerant Detection Device which is capable of determining it's specified end-of-life and replacement instructions. Refrigerant sensors for refrigerant detection systems shall only be replaced with sensors specified by the appliance manufacture.

WARNING

Take sufficient precautions in case of refrigerant leakage. If refrigerant gas leaks, ventilate the area immediately.
POSSIBLE RISKS: Excessive refrigerant concentrations in a closed room can lead to oxygen deficiency

WARNING

ALWAYS recover the refrigerant. Do NOT release them directly into the environment. Follow handling instructions carefully in compliance with national regulations.

WARNING

Check that cabling will not be subject to wear, corrosion, excessive pressure, vibration, sharp edges or any other adverse environmental effects. The check shall also take into account the effects of aging or continual vibration from sources such as compressors or fans.

Nomenclature

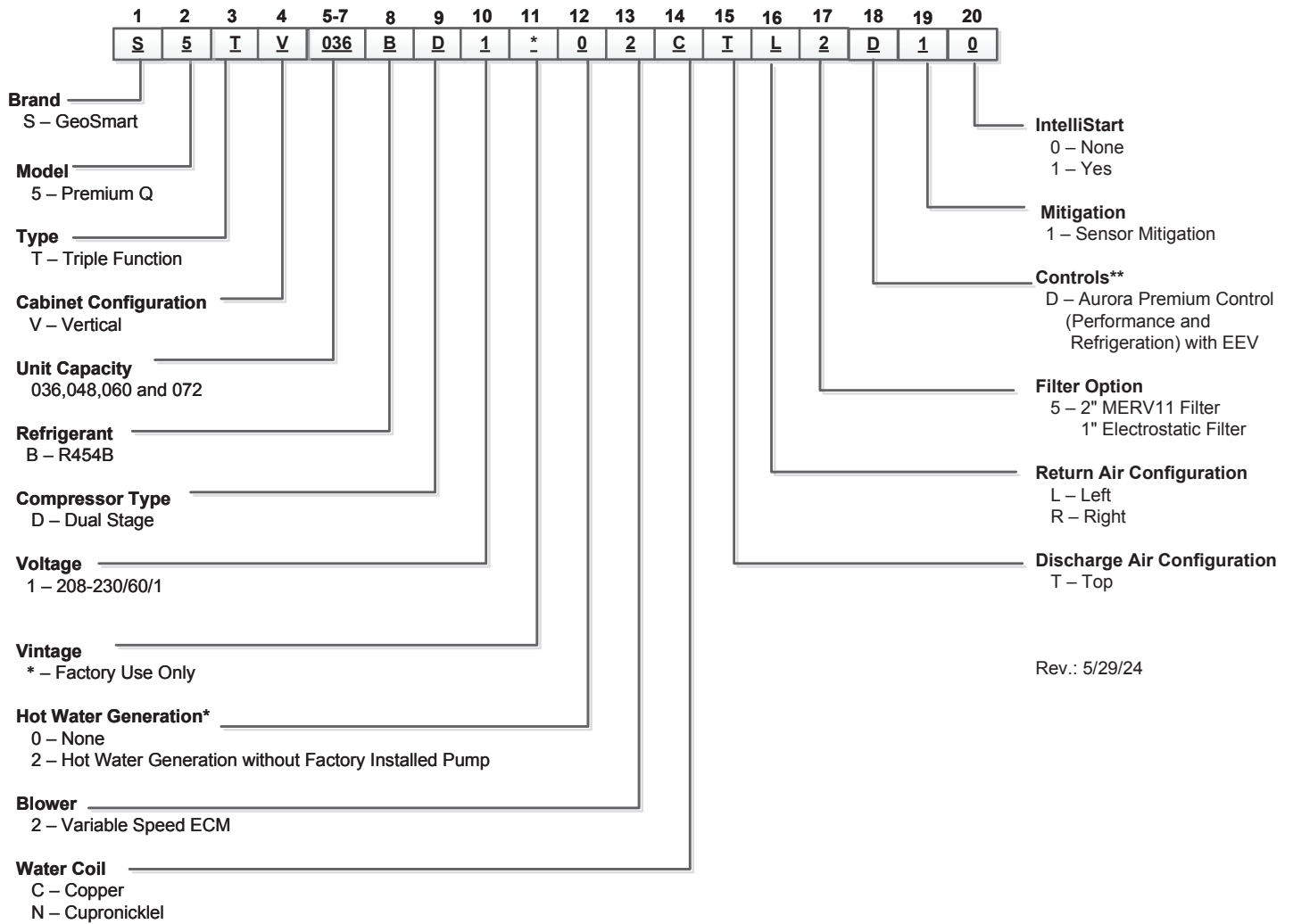

Rev.: 5/29/24

AHRI Data

The performance standard AHRI/ASHRAE/ISO 13256-1 became effective January 1, 2000 and replaces ARI Standards 320, 325, and 330. This new standard has three major categories: Water Loop (comparable to ARI 320), Ground Water (ARI 325), and Ground Loop (ARI 330). Although these standards are similar there are some differences:

Unit of Measure: The Cooling COP

The cooling efficiency is measured in EER (US version measured in Btu/h per Watt. The Metric version is measured in a cooling COP (Watt per Watt) similar to the traditional COP measurement.

Water Conditions Differences

Entering water temperatures have changed to reflect the centigrade temperature scale. For instance the water loop heating test is performed with 68°F (20°C) water rounded down from the old 70°F (21.1°C).

Air Conditions Differences

Entering air temperatures have also changed (rounded down) to reflect the centigrade temperature scale. For instance the cooling tests are performed with 80.6°F (27°C) dry bulb and 66.2°F (19°C) wet bulb entering air instead of the traditional 80°F (26.7°C) DB and 67°F (19.4°C) WB entering air temperatures. 80.6/66.2 data may be converted to 80/67 using the entering air correction table. This represents a significantly lower relative humidity than the old 80/67 of 50% and will result in lower latent capacities.

Pump Power Correction Calculation

Within each model, only one water flow rate is specified for all three groups and pumping Watts are calculated using the following formula. This additional power is added onto the existing power consumption.

- Pump power correction = (gpm x 0.0631) x (Press Drop x 2990) / 300

Where 'gpm' is waterflow in gpm and 'Press Drop' is the pressure drop through the unit heat exchanger at rated water flow in feet of head.

Blower Power Correction Calculation

Blower power is corrected to zero external static pressure using the following equation. The nominal airflow is rated at a specific external static pressure. This effectively reduces the power consumption of the unit and increases cooling capacity but decreases heating capacity. These Watts are significant enough in most cases to increase EER and COPs fairly dramatically over ARI 320, 325, and 330 ratings.

- Blower Power Correction = (cfm x 0.472) x (esp x 249) / 300

Where 'cfm' is airflow in cfm and 'esp' is the external static pressure at rated airflow in inches of water gauge.

ISO Capacity and Efficiency Calculations

The following equations illustrate cooling calculations:

- ISO Cooling Capacity = Cooling Capacity (Btu/h) + (Blower Power Correction (Watts) x 3.412)
- ISO EER Efficiency (W/W) = ISO Cooling Capacity (Btu/h) x 3.412 / [Power Input (Watts) - Blower Power Correction (Watts) + Pump Power Correction (Watt)]

The following equations illustrate heating calculations:

- ISO Heating Capacity = Heating Capacity (Btu/h) - (Blower Power Correction (Watts) x 3.412)
- ISO COP Efficiency (W/W) = ISO Heating Capacity (Btu/h) x 3.412 / [Power Input (Watts) - Blower Power Correction (Watts) + Pump Power Correction (Watt)]

Comparison of Test Conditions

	ARI 320	ISO/AHRI 13256-1 WLHP	ARI 325	ISO/AHRI 13256-1 GWHP	ARI 330	ISO/AHRI 13256-1 GLHP
Cooling						
Entering Air - DB/WB °F	80/67	80.6/66.2	80/67	80.6/66.2	80/67	80.6/66.2
Entering Water - °F	85	86	50/70	59	77	77
Fluid Flow Rate	*	**	**	**	**	**
Heating						
Entering Air - DB/WB °F	70	68	70	68	70	68
Entering Water - °F	70	68	50/70	50	32	32
Fluid Flow Rate	*	**	**	**	**	**

NOTES: * Flow rate is set by 10°F rise in standard cooling test

** Flow rate is specified by the manufacturer

Part load entering water conditions not shown

WLHP = Water Loop Heat Pump; GWHP = Ground Water Heat Pump; GLHP = Ground Loop Heat Pump

Conversions:

Airflow (lps) = cfm x 0.472;

WaterFlow (lps) = gpm x 0.0631;

ESP (Pascals) = ESP (in wg) x 249;

Press Drop (Pascals) = Press Drop (ft hd) x 2990

AHRI Data cont.

Model	Capacity Modulation	Flow Rate		Ground Water Heat Pump				Ground Loop Heat Pump			
				Cooling EWT 59°F		Heating EWT 50°F		Cooling Brine Full Load 77°F Part Load 68°F		Heating Brine Full Load 32°F Part Load 41°F	
		gpm	cfm	Capacity Btuh	EER Btuh/W	Capacity Btuh	COP	Capacity Btuh	EER Btuh/W	Capacity Btuh	COP
036	Full	9	1200	41,400	26.90	35,700	5.10	38,000	20.10	29,300	4.30
	Part	8	1000	30,800	33.60	25,400	5.20	29,600	27.80	23,500	4.70
048	Full	12	1600	52,500	24.50	47,400	4.70	49,100	18.50	38,400	4.10
	Part	11	1400	39,200	32.60	34,100	5.20	37,600	26.40	30,400	4.60
060	Full	16	1800	67,900	23.90	56,000	4.60	63,700	17.90	47,300	4.00
	Part	14	1500	48,900	31.00	38,400	4.80	47,900	25.60	35,100	4.30
072	Full	18	2000	77,700	23.00	70,700	4.50	71,500	17.80	56,100	3.90
	Part	16	1500	58,000	29.50	52,300	4.50	55,300	25.00	46,600	4.10

8/1/24

Energy Star Compliance Table

Model	Tier 3	
	Ground Water	Ground Loop
036	Yes	Yes
048	Yes	Yes
060	Yes	Yes
072	Yes	Yes

8/29/23

ENERGY STAR Rating Criteria

In order for water-source heat pumps to be ENERGY STAR rated they must meet or exceed the minimum efficiency requirements listed below.

Tier 3: 1/1/2012 - No Effective End Date Published

Water-to-Air	EER	COP
Ground Loop	17.1	3.6
Ground Water	21.1	4.1
Water-to-Water		
Ground Loop	16.1	3.1
Ground Water	20.1	3.5



Physical Data

Model	036	048	060	072
Compressor (1 each) Factory Charge R-454B, oz [kg]	Copeland Scroll			
	62 [1.75]	76 [2.15]	98 [2.77]	98 [2.77]
ECM Fan Motor & Blower				
Fan Motor Type/Speeds	ECM Variable Speed			
Fan Motor- hp [W]	1/2 [373]	1/2 [373]	1 [746]	1 [746]
Blower Wheel Size (Dia x W), in. [mm]	11 x 10 [279 x 254]	11 x 10 [279 x 254]	11 x 10 [279 x 254]	11 x 10 [279 x 254]
Coax and Water Piping				
Loop Water Connections Size - Swivel - in [mm]	1" [25.4]	1" [25.4]	1" [25.4]	1" [25.4]
Hydronic Water Connections Size - Swivel - in [mm]	1" [25.4]	1" [25.4]	1" [25.4]	1" [25.4]
HWG Connection Size - Stub - in [mm]	1/2" [12.7]	1/2" [12.7]	1/2" [12.7]	1/2" [12.7]
Coax & Piping Water Volume - gal [l]	1.3 [4.9]	1.6 [6.1]	1.6 [6.1]	1.6 [6.1]
Vertical				
Air Coil Dimensions (H x W), in. [mm]	28 x 25 [711 x 635]	32 x 25 [813 x 635]	36 x 25 [914 x 635]	36 x 25 [914 x 635]
Air Coil Total Face Area, ft2 [m2]	4.9 [0.451]	5.6 [0.570]	6.3 [0.641]	6.3 [0.641]
Air Coil Tube Size, in [mm]	3/8 [9.5]	3/8 [9.5]	3/8 [9.5]	3/8 [9.5]
Air Coil Number of rows	3	3	4	4
Filter Standard - 2" [51mm] Pleated MERV11 Disposable, in [mm]	28 x 30 [712 x 762]	32 x 30 [813 x 762]	36 x 30 [914 x 762]	36 x 30 [914 x 762]
Weight - Operating, lb [kg]	425	530	540	540
Weight - Packaged, lb [kg]	445	550	560	560

11/2/23

Dimensional Data

Top Air Discharge

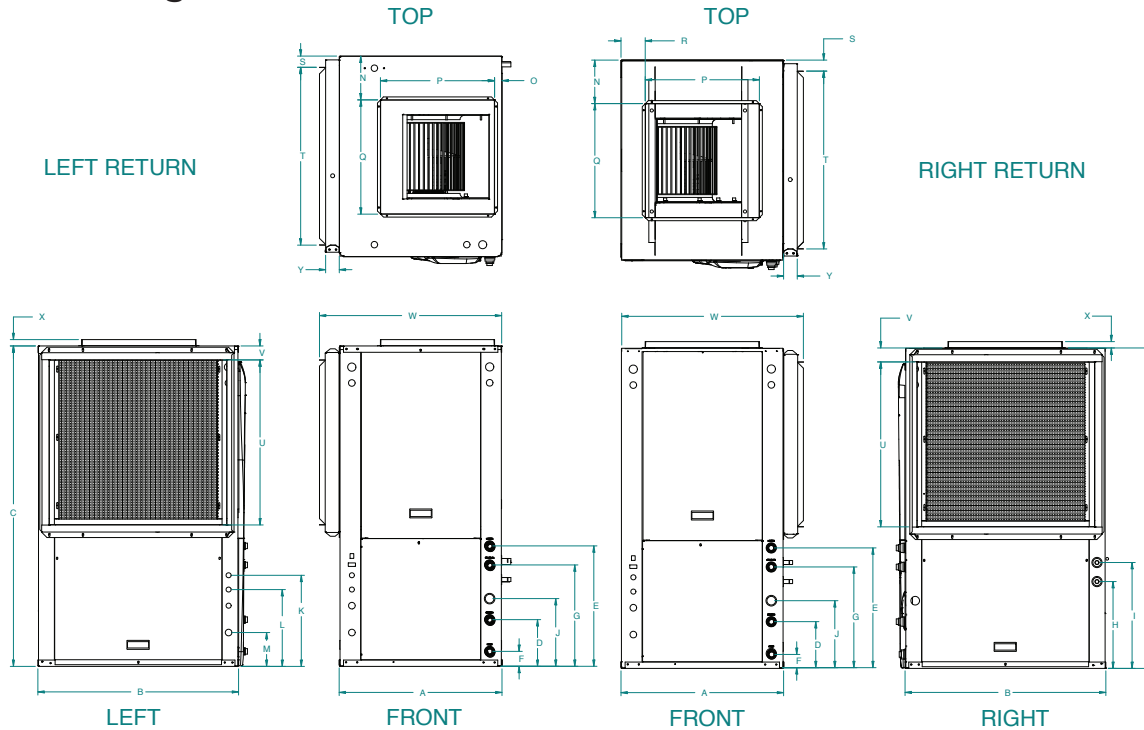

Vertical Topflow Model	Overall Cabinet			Water Connections										Electrical Connections			
	A	B	C	D	E	F	G	H	I	J	Loop Water FPT	Hydronic Water FPT	HWG (O.D.)	K	L	M	
	Width	Depth	Height	Loop In	Hydronic Out	Hydronic In	Loop Out	HWG In	HWG Out	Condensate				1/2" cond Low Voltage	1/2" cond Ext Pump	3/4" cond Power Supply	
036	in.	25.6	31.6	50.4	7.3	18.9	2.3	15.9	13.6	16.6	10.6	1" Swivel	1" Swivel	1/2" Stub	14.4	12.1	5.3
	cm.	65.0	80.3	128.0	18.5	48.0	5.8	40.4	34.5	42.2	26.9				36.6	30.7	13.5
048	in.	25.6	31.6	54.4	7.3	18.9	2.3	15.9	15.9	18.9	10.6	1" Swivel	1" Swivel	1/2" Stub	14.4	12.1	5.3
	cm.	65.0	80.3	138.2	18.5	48.0	5.8	40.4	40.4	48.0	26.9				36.6	30.7	13.5
060	in.	25.6	31.6	58.4	7.3	18.9	2.3	15.9	15.9	18.9	10.6	1" Swivel	1" Swivel	1/2" Stub	14.4	12.1	5.3
	cm.	65.0	80.3	148.3	18.5	48.0	5.8	40.4	40.4	48.0	26.9				36.6	30.7	13.5
072	in.	25.6	31.6	58.4	7.3	18.9	2.3	15.9	15.9	18.9	10.6	1" Swivel	1" Swivel	1/2" Stub	14.4	12.1	5.3
	cm.	65.0	80.3	148.3	18.5	48.0	5.8	40.4	40.4	48.0	26.9				36.6	30.7	13.5

Vertical Topflow Model	Discharge Connection duct flange installed (±0.10 in)					Return Connection using std deluxe filter rack (±0.10 in)						Misc			
	N	O	P	Q	R	S	T	U	V	W	X	Y			
			Supply Width	Supply Depth			Return Depth	Return Height							
036	in.	6.9	1.1	18.0	18.0	3.8	1.7	28.1	26.0	1.7	28.7	1.0	2.1		
	cm.	17.5	2.8	45.7	45.7	9.7	4.3	71.4	66.0	4.3	72.9	2.5	5.3		
048	in.	6.9	1.1	18.0	18.0	3.8	1.7	28.1	30.0	1.7	28.7	1.0	2.1		
	cm.	17.5	2.8	45.7	45.7	9.7	4.3	71.4	76.2	4.3	72.9	2.5	5.3		
060	in.	6.9	1.1	18.0	18.0	3.8	1.7	28.1	34.0	1.7	28.7	1.0	2.1		
	cm.	17.5	2.8	45.7	45.7	9.7	4.3	71.4	86.4	4.3	72.9	2.5	5.3		
072	in.	6.9	1.1	18.0	18.0	3.8	1.7	28.1	34.0	1.7	28.7	1.0	2.1		
	cm.	17.5	2.8	45.7	45.7	9.7	4.3	71.4	86.4	4.3	72.9	2.5	5.3		

Condensate is 3/4" PVC female glue socket and is switchable from side to front 11/14/23
 Unit shipped with deluxe 2" (field adjustable to 1") duct collar/filter rack extending from unit 3.25" and is suitable for duct connection.
 Discharge flange is field installed and extends 1" [25.4mm] from cabinet
 Decorative molding and water connections extend 1.2" [30.5mm] beyond front of cabinet.

Electrical Data

Model	Rated Voltage	Voltage Min/Max	Compressor				Int Pump FLA	Ext Loop FLA	Fan Motor FLA	Total Unit FLA	Min Circ Amp	Max Fuse/HACR
			MCC	RLA	LRA	LRA**						
036	208-230/60/1	187/253	22.7	14.6	90.0	32.4	1.07	5.4	4.0	25.1	28.7	40
048	208-230/60/1	187/253	28.6	18.3	138.0	49.7	1.07	5.4	4.0	28.8	33.3	50
060	208-230/60/1	187/253	39.3	25.2	147.3	51.5	1.07	5.4	7.0	38.7	45.0	70
072	208-230/60/1	187/253	43.7	28.0	160.0	56.0	1.07	5.4	7.0	41.5	48.5	70

Rated Voltage of 208-230/60/1.

11/29/23

HACR circuit breaker in USA only.

Min/Max Voltage of 187/254.

Local electrical codes overrule any wiring recommendations.

All fuses Class RK-5.

* With optional 1 HP ECM motor

**With optional IntelliStart

Auxiliary Heat Ratings

Model	KW		Stages	BTU/HR		Min CFM		
	208V	230V		208V	230V		036	048 - 072
EAL10B	7.2	9.6	2	24,600	32,700	1100	•	•
EAL15B	10.8	14.4	2	36,900	49,100	1250	•	•
EAL20B	14.4	19.2	2	49,200	65,500	1500		•

Air flow level for auxiliary heat (Aux) must be equal to or above the minimum CFM in this table

Auxiliary Heat Electrical Data

Model	Supply Circuit	Heater Amps		Min Circuit Amp		Max Fuse (USA)		Max Fuse (CAN)		Max CKT BRK	
		208 V	240 V	208 V	240 V	208 V	240 V	208 V	240 V	208 V	240 V
EAL10	Single	34.7	40	53.3	60	60	60	60	60	60	60
EAL15	Single	52.0	60	75.0	85	80	90	80	90	70	100
	L1/L2	34.7	40	53.3	60	60	60	60	60	60	60
	L3/L4	17.3	20	21.7	25	25	25	25	25	20	30
EAL20	Single	69.3	80	96.7	110	100	110	100	110	100	100
	L1/L2	34.7	40	53.3	60	60	60	60	60	60	60
	L3/L4	34.7	40	43.3	50	45	50	45	50	40	50

All heaters rated single phase 60 cycle and include unit fan load

All fuses type "D" time delay (or HACR circuit breaker in USA)

Blower Performance Data

MODEL	MAX ESP	AIR FLOW SPEED SETTINGS											
		1	2	3	4	5	6	7	8	9	10	11	12
036	0.50	650	750 G	850	1000	1100 L	1200	1300 H	1400	1500	1550 Aux		
048	0.50	650	800 G	900	1050	1150	1250	1350 L	1450	1550 H	1575 Aux		
060	0.75	800	950 G	1100	1300	1500 L	1750	1950 H	2100	2300	2325 Aux		
072	0.75	800	950 G	1100	1300	1500	1750 L	1950	2100 H	2300	2325 Aux		

8/29/23

Factory settings are at recommended G-L-H-Aux speed settings

L-H settings MUST be located within boldface CFM range

"Aux" is factory setting for auxiliary heat and must be equal to or above the "H" setting as well as at least the minimum required for the auxiliary heat package

"G" may be located anywhere within the airflow table

CFM is controlled within ±5% up to the maximum ESP

Max ESP includes allowance for wet coil and standard filter

Blower Performance Data

Setting Blower Speed - Variable Speed ECM

The ABC board's Yellow Config LED will flash the current ECM blower speed selections for "G", low, and high continuously with a short pause in between. The speeds can also be confirmed with the AID Tool under the Setup/ECM Setup screen. The Aux will not be flashed but can be viewed in the AID Tool. The ECM blower motor speeds can be field adjusted with or without using an AID Tool.

ECM Setup without an AID Tool

The blower speeds for "G", Low (Y1), High (Y2), and Aux can be adjusted directly at the Aurora ABC board which utilizes the push button (SW1) on the ABC board. This procedure is outlined in the ECM Configuration Mode portion of the Aurora 'Base' Control System section. The Aux cannot be set manually without an AID Tool.

ECM Setup with an AID Tool

A much easier method utilizes the AID Tool to change the airflow using the procedure below. First navigate to the Setup screen and then select ECM Setup. This screen displays the current ECM settings. It allows the technician to enter the setup screens to change the ECM settings. Change the highlighted item using the ◀ and ▶ buttons and then press the ⏎ button to select the item.

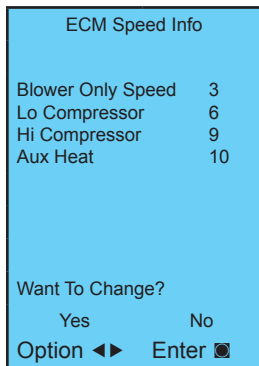

Selecting YES will enter ECM speed setup, while selecting NO will return to the previous screen.

ECM Speed Setup - These screens allow the technician to select the "G", low, high, and auxiliary heat blower speed for the ECM blower motor. Change the highlighted item using the ▲ and ▼ buttons. Press the ⏎ button to select the speed.

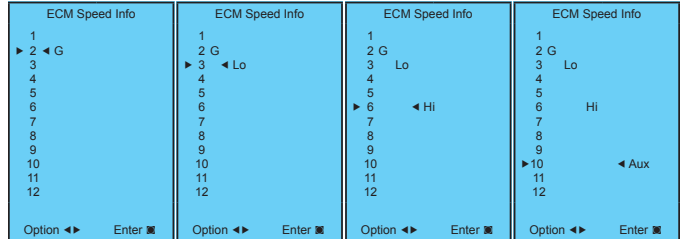

After the auxiliary heat speed setting is selected the AID Tool will automatically transfer back to the ECM Setup screen.

Cooling Airflow Setup - These screens allow the technician to select -15%, -10%, -5%, None or +5%. Change the adjustment percentage using the ▲ and ▼ buttons. Press the ⏎ button to save the change.

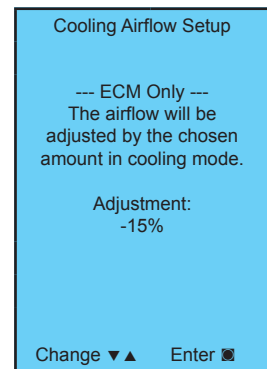
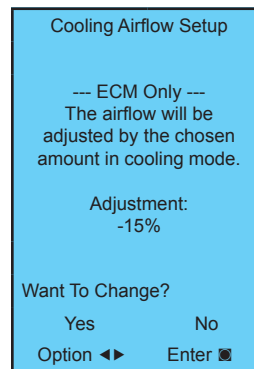

Antifreeze Corrections

Catalog performance can be corrected for antifreeze use. Please use the following table and note the example given.

Antifreeze Type	Antifreeze % by wt	Heating	Cooling	Pressure Drop
EWT - °F [°C]		30 [-1.1]	90 [32.2]	30 [-1.1]
Water	0	1.000	1.000	1.000
	10	0.973	0.991	1.075
Ethylene Glycol	20	0.943	0.979	1.163
	30	0.917	0.965	1.225
	40	0.890	0.955	1.324
	50	0.865	0.943	1.419
	10	0.958	0.981	1.130
Propylene Glycol	20	0.913	0.969	1.270
	30	0.854	0.950	1.433
	40	0.813	0.937	1.614
	50	0.770	0.922	1.816
	10	0.927	0.991	1.242
Ethanol	20	0.887	0.972	1.343
	30	0.856	0.947	1.383
	40	0.815	0.930	1.523
	50	0.779	0.911	1.639
	10	0.957	0.986	1.127
Methanol	20	0.924	0.970	1.197
	30	0.895	0.951	1.235
	40	0.863	0.936	1.323
	50	0.833	0.920	1.399



WARNING: Gray area represents antifreeze concentrations greater than 35% by weight and should be avoided due to the extreme performance penalty they represent.

Antifreeze Correction Example

Antifreeze solution is Propylene Glycol 20% by weight. Determine the corrected heating and cooling performance at 30°F and 90°F respectively as well as pressure drop at 30°F for NS*022-ECM.

The corrected cooling capacity at 90°F would be: 22,400 MBtu/h x 0.969 = 21,706 MBtu/h

The corrected heating capacity at 30°F would be: 14,500 MBtu/h x 0.913 = 13,239 MBtu/h

The corrected pressure drop at 30°F and 6 gpm would be: 6.6 feet of head x 1.270 = 8.38 feet of head

Correction Factor Tables

Air Flow Corrections (Dual Capacity Part Load)

Airflow		Cooling				Heating		
cfm Per Ton of Clg	% of Nominal	Total Cap	Sens Cap	Power	Heat of Rej	Htg Cap	Power	Heat of Ext
240	60	0.922	0.778	0.956	0.924	0.943	1.239	0.879
275	69	0.944	0.830	0.962	0.944	0.958	1.161	0.914
300	75	0.957	0.866	0.968	0.958	0.968	1.115	0.937
325	81	0.970	0.900	0.974	0.970	0.977	1.075	0.956
350	88	0.982	0.933	0.981	0.980	0.985	1.042	0.972
375	94	0.991	0.968	0.991	0.991	0.993	1.018	0.988
400	100	1.000	1.000	1.000	1.000	1.000	1.000	1.000
425	106	1.007	1.033	1.011	1.008	1.007	0.990	1.010
450	113	1.013	1.065	1.023	1.015	1.012	0.987	1.018
475	119	1.017	1.099	1.037	1.022	1.018	0.984	1.025
500	125	1.020	1.132	1.052	1.027	1.022	0.982	1.031
520	130	1.022	1.159	1.064	1.030	1.025	0.979	1.034

5/30/06

Air Flow Corrections (Dual Capacity Full Load)

Airflow		Cooling				Heating		
cfm Per Ton of Clg	% of Nominal	Total Cap	Sens Cap	Power	Heat of Rej	Htg Cap	Power	Heat of Ext
240	60	0.922	0.786	0.910	0.920	0.943	1.150	0.893
275	69	0.944	0.827	0.924	0.940	0.958	1.105	0.922
300	75	0.959	0.860	0.937	0.955	0.968	1.078	0.942
325	81	0.971	0.894	0.950	0.967	0.977	1.053	0.959
350	88	0.982	0.929	0.964	0.978	0.985	1.031	0.973
375	94	0.992	0.965	0.982	0.990	0.993	1.014	0.988
400	100	1.000	1.000	1.000	1.000	1.000	1.000	1.000
425	106	1.007	1.034	1.020	1.010	1.007	0.990	1.011
450	113	1.012	1.065	1.042	1.018	1.013	0.983	1.020
475	119	1.017	1.093	1.066	1.026	1.018	0.980	1.028
500	125	1.019	1.117	1.092	1.033	1.023	0.978	1.034
520	130	1.020	1.132	1.113	1.038	1.026	0.975	1.038

5/30/06

Cooling Capacity Corrections

Entering Air WB °F	Total Clg Cap	Sensible Cooling Capacity Multipliers - Entering DB °F										Power Input	Heat of Rejection
		60	65	70	75	80	80.6	85	90	95	100		
55	0.898	0.723	0.866	1.048	1.185	*	*	*	*	*	*	0.985	0.913
60	0.912		0.632	0.880	1.078	1.244	1.260	*	*	*	*	0.994	0.927
63	0.945			0.768	0.960	1.150	1.175	*	*	*	*	0.996	0.954
65	0.976			0.694	0.881	1.079	1.085	1.270	*	*	*	0.997	0.972
66.2	0.983			0.655	0.842	1.040	1.060	1.232	*	*	*	0.999	0.986
67	1.000			0.616	0.806	1.000	1.023	1.193	1.330	1.480	*	1.000	1.000
70	1.053				0.693	0.879	0.900	1.075	1.205	1.404	*	1.003	1.044
75	1.168					0.687	0.715	0.875	1.040	1.261	1.476	1.007	1.141

NOTE: * Sensible capacity equals total capacity at conditions shown.

3/28/12

Heating Capacity Corrections

Ent Air DB °F	Heating Corrections		
	Htg Cap	Power	Heat of Ext
45	1.062	0.739	1.158
50	1.050	0.790	1.130
55	1.037	0.842	1.096
60	1.025	0.893	1.064
65	1.012	0.945	1.030
68	1.005	0.976	1.012
70	1.000	1.000	1.000
75	0.987	1.048	0.970
80	0.975	1.099	0.930

11/10/09

Heat of Extraction/Heat of Rejection

Model	GPM	Heat of Extraction (kBtuh)				Heat of Rejection (kBtuh)					
		30°F	50°F	70°F	90°F	30°F	50°F	70°F	90°F	110°F	
036	Part Load	4.0		19.2	24.4	29.2		34.5	33.4	32.1	
		6.0	14.3	20.0	25.6	31.2	29.5	34.9	33.6	32.6	29.4
		8.0	14.7	20.5	26.4	32.3	29.8	35.1	33.7	32.8	30.0
	Full Load	5.0		27.6	24.5	40.4		46.9	46.8	43.9	
		7.0	20.9	28.8	25.8	43.1	36.9	47.3	47.0	44.7	42.0
		9.0	21.5	29.5	36.9	44.7	37.2	47.7	47.1	44.9	42.2
048	Part Load	5.0		24.7	31.6	38.3		41.3	41.4	37.5	
		8.0	17.7	25.8	33.5	40.7	37.5	42.8	41.9	39.6	37.5
		11.0	19.1	27.1	34.4	40.8	37.8	43.4	42.0	40.0	37.9
	Full Load	6.0		36.4	45.0	51.1		60.1	59.4	55.9	
		9.0	27.7	38.0	47.7	54.5	50.9	60.7	59.5	56.9	53.1
		12.0	28.4	39.0	49.2	56.5	51.2	61.1	59.6	57.2	53.3
060	Part Load	6.0		30.3	40.6	52.8		55.9	55.6	52.9	
		10.0	20.0	31.6	43.6	56.0	45.9	58.6	56.2	53.0	48.2
		14.0	21.6	33.3	44.7	56.2	46.3	59.4	56.4	53.7	48.7
	Full Load	8.0		45.3	58.9	71.2		73.7	79.4	76.4	
		12.0	33.8	47.3	62.1	75.7	63.5	80.9	80.1	76.6	75.1
		16.0	36.4	49.8	63.7	75.8	64.0	82.0	80.5	77.5	75.9
072	Part Load	10.0		39.4	55.0	66.7		67.3	68.3	66.4	
		13.0	28.6	41.1	56.4	70.8	62.7	71.8	68.7	66.6	62.9
		16.0	30.9	43.3	57.9	70.9	63.3	72.8	69.2	67.4	63.5
	Full Load	12.0		55.4	73.6	84.7		92.9	92.9	88.6	
		15.0	42.2	57.8	74.7	90.4	84.0	93.7	93.5	90.3	86.4
		18.0	43.2	59.3	77.1	93.7	84.1	94.3	94.0	90.7	86.8

11/29/23

Water Quality

Material		Copper	90/10 Cupronickel	316 Stainless Steel
pH	Acidity/Alkalinity	7 - 9	7 - 9	7 - 9
Scaling	Calcium and Magnesium Carbonate	(Total Hardness) less than 350 ppm	(Total Hardness) less than 350 ppm	(Total Hardness) less than 350 ppm
Corrosion	Hydrogen Sulfide	Less than 0.5 ppm (rotten egg smell appears at 0.5 ppm)	10 - 50 ppm	Less than 1 ppm
	Sulfates	Less than 125 ppm	Less than 125 ppm	Less than 200 ppm
	Chlorine	Less than 0.5 ppm	Less than 0.5 ppm	Less than 0.5 ppm
	Chlorides	Less than 20 ppm	Less than 125 ppm	Less than 300 ppm
	Carbon Dioxide	Less than 50 ppm	10 - 50 ppm	10 - 50 ppm
	Ammonia	Less than 2 ppm	Less than 2 ppm	Less than 20 ppm
	Ammonia Chloride	Less than 0.5 ppm	Less than 0.5 ppm	Less than 0.5 ppm
	Ammonia Nitrate	Less than 0.5 ppm	Less than 0.5 ppm	Less than 0.5 ppm
	Ammonia Hydroxide	Less than 0.5 ppm	Less than 0.5 ppm	Less than 0.5 ppm
	Ammonia Sulfate	Less than 0.5 ppm	Less than 0.5 ppm	Less than 0.5 ppm
	Total Dissolved Solids (TDS)	Less than 1000 ppm	1000 - 1500 ppm	1000 - 1500 ppm
	LSI Index	+0.5 to -0.5	+0.5 to -0.5	+0.5 to -0.5
Iron Fouling (Biological Growth)	Iron, FE ²⁺ (Ferrous) Bacterial Iron Potential	< 0.2 ppm	< 0.2 ppm	< 0.2 ppm
	Iron Oxide	Less than 1 ppm, above this level deposition will occur	Less than 1 ppm, above this level deposition will occur	Less than 1 ppm, above this level deposition will occur
Erosion	Suspended Solids	Less than 10 ppm and filtered for max. of 600 micron size	Less than 10 ppm and filtered for max. of 600 micron size	Less than 10 ppm and filtered for max. of 600 micron size
	Threshold Velocity (Fresh Water)	< 6 ft/sec	< 6 ft/sec	< 6 ft/sec

NOTES: Grains = ppm divided by 17
mg/L is equivalent to ppm

2/22/12

Water Quality

It is the responsibility of the system designer and installing contractor to ensure that acceptable water quality is present and that all applicable codes have been met in these installations. Failure to adhere to the guidelines in the water quality table could result in loss of warranty. In ground water situations where scaling could be heavy or where biological growth such as iron bacteria will be present, a closed loop system is recommended. The heat exchanger coils in ground water systems may, over a period of time, lose heat exchange capabilities due to a buildup of mineral deposits inside. These can be cleaned, but only by a qualified service mechanic, as special solutions and pumping equipment are required. Hot water generator coils can likewise become scaled and possibly plugged. In areas with extremely hard water, the owner should be informed that the heat exchanger may require occasional flushing.

Heat pumps with cupronickel heat exchangers are recommended for open loop applications due to the increased resistance to build-up and corrosion, along with reduced wear caused by acid cleaning.

Water Treatment

Do not use untreated or improperly treated water. Equipment damage may occur. The use of improperly treated or untreated water in this equipment may result in scaling, erosion, corrosion, algae or slime. Purchase of a pre-mix antifreeze could significantly improve system reliability if the water quality is controlled and there are additives in the mixture to inhibit

corrosion. There are many examples of such fluids on the market today such as Environol™ 1000 (pre-mix ethanol), and others. The services of a qualified water treatment specialist should be engaged to determine what treatment, if any, is required. The product warranty specifically excludes liability for corrosion, erosion or deterioration of equipment.

The heat exchangers and water lines in the units are copper or cupronickel tube. There may be other materials in the buildings piping system that the designer may need to take into consideration when deciding the parameters of the water quality. If antifreeze or water treatment solution is to be used, the designer should confirm it does not have a detrimental effect on the materials in the system.

Contaminated Water

In applications where the water quality cannot be held to prescribed limits, the use of a secondary or intermediate heat exchanger is recommended to separate the unit from the contaminated water. The table above outlines the water quality guidelines for unit heat exchangers. If these conditions are exceeded, a secondary heat exchanger is required. Failure to supply a secondary heat exchanger where needed will result in a warranty exclusion for primary heat exchanger corrosion or failure.

Operating Parameters

		Forced Air Cooling											
Entering Water Temp F	Water Flow (GPM/ Ton)	Suction Pressure PSIG	Discharge Pressure PSIG	Super-heat °F	Sub-cooling °F	Water Temp Rise °F	Air Temp Drop °F DB						
20	1.5	Operation Not Recommended											
	2.25												
	3.0												
30	1.5	Operation Not Recommended											
	2.25							118-114	115-156	22° - 40°	4° - 20°	8-13	14-22
	3.0							106-114	125-166	28° - 40°	4° - 20°	8-13	18-25
50	1.5	144-159	172-192	9° - 19°	6° - 18°	8-15	18-25						
	2.25	133-149	179-202	7° - 17°	6° - 18°	7-12	22-26						
	3.0	125-142	182-210	7° - 20°	6° - 18°	8-13	21-25						
70	1.5	149-159	207-225	8° - 15°	5° - 16°	7-16	18-23						
	2.25	136-148	226-252	7° - 14°	5° - 16°	6-13	18-25						
	3.0	130-140	245-282	6° - 13°	5° - 16°	8-14	20-25						
90	1.5	153-164	286-302	7° - 18°	5° - 17°	8-19	17-21						
	2.25	143-153	304-329	7° - 14°	5° - 17°	6-13	18-23						
	3.0	135-147	324-356	6° - 15°	5° - 17°	9-13	19-23						
110	1.5	Operation Not Recommended											
	2.25							142-159	397-421	7° - 12°	5° - 15°	5-12	18-22
	3.0							137-149	416-448	6° - 12°	5° - 15°	7-11	18-22
120	1.5	Operation Not Recommended											
	2.25							144-158	456-487	7° - 12°	5° - 15°	8-19	17-21
	3.0							139-151	465-502	6° - 12°	5° - 15°	5-12	17-21

*Based on Nominal 400 cfm per ton airflow and 70°F EAT heating and 80/67°F EAT cooling

**Cooling air and water numbers can vary greatly with changes in humidity

*** No Desuperheater

		Forced Air Heating											
Entering Water Temp F	Water Flow (GPM/ Ton)	Suction Pressure PSIG	Discharge Pressure PSIG	Super-heat °F	Sub-cooling °F	Water Temp Drop °F	Air Temp Rise °F DB						
20	1.5	Operation Not Recommended											
	2.25												
	3.0							54-63	264-282	7° - 15°	5° - 16°	3 - 8	16-20
30	1.5	Operation Not Recommended											
	2.25							70-83	234-265	6° - 18°	3° - 16°	4 - 9	16-20
	3.0							64-78	274-300	6° - 18°	3° - 16°	3 - 8	18-23
50	1.5	119-130	273-325	10° - 18°	6° - 20°	4 - 9	21-29						
	2.25	106-119	292-330	6° - 18°	6° - 20°	4 - 8	20-29						
	3.0	94-108	304-332	6° - 18°	6° - 20°	4 - 8	22-30						
70	1.5	158-173	305-351	10° - 18°	4° - 19°	6-10	22-28						
	2.25	143-160	312-361	8° - 16°	4° - 19°	5 - 9	28-36						
	3.0	130-144	328-374	8° - 16°	4° - 19°	4 - 9	30-37						
90	1.5	198-212	322-398	12° - 24°	5° - 18°	8-12	23-32						
	2.25	181-206	332-402	8° - 16°	5° - 18°	6-10	32-42						
	3.0	170-186	352-422	8° - 16°	5° - 18°	6-10	37-42						
110	1.5	Operation Not Recommended											
	2.25												
	3.0												
120	1.5	Operation Not Recommended											
	2.25												
	3.0												

*Based on Nominal 400 cfm per ton airflow and 70°F EAT heating and 80/67°F EAT cooling

**Cooling air and water numbers can vary greatly with changes in humidity

*** No Desuperheater

Operating Parameters (cont.)

Water Heating												
Entering Source Water Temp F	80°F ELT				100°F ELT				120°F ELT			
	Suction Pressure PSIG	Discharge Pressure PSIG	Super-heat °F	Sub-cooling °F	Suction Pressure PSIG	Discharge Pressure PSIG	Super-heat °F	Sub-cooling °F	Suction Pressure PSIG	Discharge Pressure PSIG	Super-heat °F	Sub-cooling °F
30	62-80	248-284	5° - 12°	4° - 19°	63-82	328-376	8° - 15°	10° - 19°	65-84	410-468	7° - 14°	11° - 29°
50	95-112	256-298	6° - 16°	4° - 19°	96-115	334-388	8° - 16°	7° - 20°	98-118	415-476	7° - 14°	9° - 27°
70	128-144	264-312	8° - 17°	4° - 19°	130-148	342-398	8° - 16°	6° - 22°	134-152	420-484	8° - 15°	7° - 25°

*Water Heating mode allows only high capacity compressor operation.

11/28/23

*** No Desuperheater

Pressure Drop

Model	GPM	Pressure Drop (psi)				
		30°F	50°F	70°F	90°F	110°F
036 full load	5	2.5	2.3	2.2	2.0	1.9
	7	3.9	3.6	3.4	3.2	2.9
	9	5.3	5.0	4.7	4.5	4.1
	11	6.7	6.5	6.0	5.8	5.3
036 part load	4	2.0	1.9	1.8	1.6	1.5
	6	3.1	2.9	2.7	2.5	2.3
	8	4.5	4.2	3.9	3.7	3.4
	10	5.9	5.5	5.1	4.9	4.5
048 full load	6	1.8	1.7	1.6	1.5	1.4
	9	3.2	3.0	2.8	2.6	2.4
	12	4.8	4.5	4.2	3.9	3.6
	15	6.4	6.0	5.6	5.2	4.8
048 part load	5	1.5	1.4	1.3	1.2	1.1
	8	2.8	2.6	2.5	2.3	2.1
	11	4.2	3.9	3.7	3.4	3.2
	14	5.6	5.2	4.9	4.5	4.3
060 full load	8	2.3	2.2	2.0	1.9	1.7
	12	4.8	4.5	4.2	3.9	3.6
	16	7.3	6.8	6.4	6.0	5.5
	20	9.8	9.1	8.6	8.1	7.4
060 part load	6	1.6	1.5	1.4	1.3	1.2
	10	3.6	3.4	3.2	3.0	2.8
	14	5.8	5.4	5.1	4.8	4.4
	18	8.0	7.4	7.0	6.6	6.0
072 full load	12	4.5	4.3	4.0	3.7	3.5
	15	7.0	6.6	6.2	5.8	5.4
	18	9.4	8.9	8.3	7.5	7.2
	21	11.6	11.2	10.4	9.2	9.0
072 part load	10	3.1	2.9	2.7	2.5	2.3
	13	5.0	4.7	4.4	4.1	3.8
	16	7.2	6.8	6.3	5.9	5.5
	19	9.5	9.0	8.4	7.7	7.3

11/28/23

Operation Logic Data Table

Operation Logic Table	Heating				Cooling		Hot Water Mode
	STG1	STG2	STG3	EMERG	STG1	STG2	
Compressor	On	On	On	Off	On	On	Stg 2 On
Reversing Valve	Off	Off	Off	Off	On	On	Off
Loop Pump	On	On	On	Off	On	On	On
Load Pump	Off	Off	Off	Off	Off	Off	On
Aux Heater	Off	Off	Staged	Staged	Off	Off	Off
Solenoid Valve	On	On	On	Off	On	On	Off
Diverting Valve	Off	Off	Off	Off	Off	Off	On
ECM Speed	On	On	On	On	On	On	Off
T-Stat Signal	Y1	Y1, Y2	Y1, Y2, W	W	Y1, O	Y1, Y2, O	HW

Aurora Control System

Control System Overview

The unit uses the Aurora Control system. This system contains the Aurora ‘Base’ control board (ABC), two Aurora ‘Advanced’ expansion control boards (AXB1 and AXB2) and the Aurora ‘Sensor’ board (ASB). The ABC features microprocessor control and HP, LP, condensate and freeze detection, over/under voltage faults, along with communicating thermostat capability for complete fault detection text at the thermostat. The AXB1 control board communicates with the ABC and provides loop pump slaving, intelligent hot water generator control, variable speed pump capability, along with standard energy, performance, and refrigeration monitoring sensors. The AXB2 control board also communicates with the ABC and provides the hydronic operation of the unit. This includes diverting valve operation, load side performance, load pump and tank auxiliary heat energy monitoring and compressor discharge temperature. The ASB board is a refrigeration leak detection sensor board that is an interface between leak detection sensor and the ABC control board.

Aurora ‘Base’ Control

The Aurora ‘Base’ Control (ABC) System is a complete residential and commercial comfort system that brings all aspects of the HVAC system into one cohesive module network. The ABC features microprocessor control and HP, LP, condensate and freeze detection, over/under voltage faults, along with communicating thermostat capability for complete fault detection text at the thermostat.

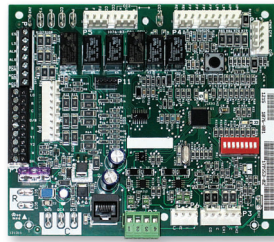

Aurora uses the Modbus communication protocol to communicate between modules. Each module contains the logic to control all features that are connected to the module. The Aurora ‘Base’ Control (ABC) has two Modbus channels. The first channel is configured as a master for connecting to devices such as a communicating thermostat, expansion board, or other slave devices. The second channel is configured as a slave for connecting the Aurora Interface Diagnostics Tool (AID Tool).

Aurora ‘Advanced’ Control

The Aurora ‘Advanced’ Control expands on the capability of the Aurora ‘Base’ Control (ABC) System by adding the Aurora Expansion Board (AXB). The additional features include compressor current monitoring, loop pump slaving, intelligent hot water generator control, variable speed pump capability, and also allows for optional energy, refrigeration, and performance monitoring factory installed add-on sensor kits. The AXB also features a second field configurable accessory relay, and two home automation inputs that are AID configurable for different types of alarms from sump pumps to home security. The Smart Grid input is AID configurable with many options to react to Utility controlled relay operation for ON Peak optimization. The AXB also expands the communication capability for IntelliZone2 ready operation as well as other expansion with the ClimateTalk protocol.

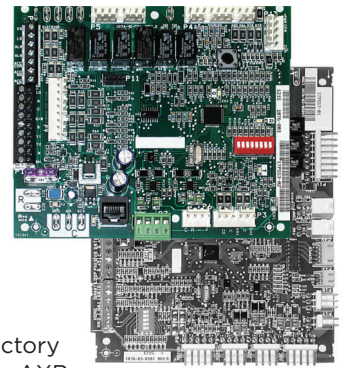



Aurora Control Features	Description	Aurora ‘Advanced’
Microprocessor Compressor Control	Microprocessor control of compressor for timings with FP1, HP, LP, Condensate, assignable Acc relay	•
Advanced Microprocessor Features	Smart Grid, Home Automation Alarm Inputs, and Accessory2 Relay (HRV/ERV)	•
Advanced Hot Water Generator Control	Microprocessor and separate power relay for Hot Water Generator Pump with digital temperature monitoring and multiple HWG setpoint selection.	•
Base Loop Pump Control	Compressor Contactor powers Loop Pump with inline circuit breaker and no loop pump slaving capability.	See below
Advanced Speed Pump Control	Microprocessor and separate power relay for loop pump and inline circuit breakers and loop pump slaving.	•
Variable Speed Pump	Capable of setup, monitoring and controlling a variable speed flow center.	•
Compressor Monitoring	Control monitors compressor starts for high current, missing let etc.	•
Smart Grid/Utility Input	Allows simple input to externally enable of occupied/unoccupied mode for basic utility time of use programs.	Dry Contact x1
Home Automation Alarm Input	Allows simple input to signal sump, security, or smoke/CO sensor alarms from other home automation or security systems. The two inputs can be field configured to a number of options and logic.	Dry Contactx2

Aurora Control System

Service Device	Description	Aurora 'Advanced'
 Aurora Interface and Diagnostics (AID) Tool	Allows setup, monitoring and troubleshooting of any Aurora Control. NOTE: Although the ABC has basic compatibility with all Aurora, new product features may not be available on older AID Tools. To simplify the basic compatibility ensure the version of AID is at least the same or greater than the ABC software version.	For Service (Ver. 2.20 or greater)

Add On Control Feature Kits (field or factory installed)	Description	Aurora 'Advanced'
Geo Energy Monitoring	Monitors realtime power consumption of compressor, blower, aux heat and pump.	Standard
Refrigeration Monitoring	Monitors realtime pressures, temperatures, superheat, and subcooling. AXB required.	Standard
Performance Monitoring	Monitors air and water temperatures, and water flow rate and calculates heat of extraction/rejection.	Standard
Data Logging (AWL) Kit	Allows data logging of up to 12 months. Can also be temporarily installed.	Optional
HAN/Smart Grid Com (AWL and Portal) Kit	Allows direct communication of the Aurora to Smart Meters, HAN, and internet.	Optional
AXB for advanced hot water generator control, flow center linking, variable speed pump, IntelliZone2	Added to unit for key features of advanced hot water generator control, advanced loop control/linking, IntelliZone2 communication, and variable speed pump control.	Standard

Add On Thermostats and Zoning	Description	Aurora Advanced
 TPCC32U03 - Color Touchscreen Communicating Thermostat	4.3 in. color touchscreen communicating thermostat with full English fault codes and alerts. Color thermostat allows instantaneous energy measurement and 13 month energy usage history. Compatible with AWL.	Optional
 IntelliZone2 Zoning CURRENTLY NOT AVAILABLE	IntelliZone2 is a communicating zoning system that includes color main thermostat and up to 6 zones (with variable speed, 4 zones (with dual capacity), and 2 zones (with single speed). There are 3 thermostat options (MasterStat, SensorStat, ZoneStat). Compatible with AWL.	Optional (IntelliZone2 Preferred)

Aurora Control System

Aurora 'Base' Control

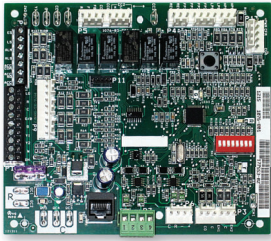

NOTE: Refer to the Aurora Base Control Application and Troubleshooting Guide and the Instruction Guide: Aurora Interface and Diagnostics (AID) Tool for additional information.

Control Features

Software ABC Standard Version 4.0

Single or Dual Capacity Compressors

Either single or dual capacity compressors can be operated.

Variable Speed ECM Blower Motor Option

A Variable Speed ECM blower motor can be driven directly using the onboard PWM output. Four blower speeds are available based upon the G, Y1, Y2, and W input signals to the board. The blower speeds can be changed either by the ECM manual configurations mode method or by using the Aurora AID Tool directly. All four blower speeds can be set to the same speed if desired.

Other Control Features

- Random start at power up
- Anti-short cycle protection
- High and low pressure cutouts
- Loss of charge
- Water coil freeze detection
- Air coil freeze detection
- Over/under voltage protection
- Condensate overflow sensor
- Load shed
- Dehumidification (where applicable)
- Emergency shutdown
- Hot gas reheat operation (where applicable)
- Diagnostic LED
- Test mode push button switch
- Two auxiliary electric heat outputs
- Alarm output
- Accessory output with N.O. and N.C.
- Modbus communication (master)
- Modbus communication (slave)

Field Selectable Options via Hardware

DIP Switch (SW1) - Test/Configuration Button (See SW1 Operation Table)

Test Mode

The control is placed in the test mode by holding the push button switch SW1 for 2 - 5 seconds. In test mode most of the control timings will be shortened by a factor of sixteen (16). LED3 (green) will flash at 1 second on and 1 second off. Additionally, when entering test mode LED1 (red) will flash the last lockout one time. Test mode will automatically time out after 30 minutes. Test mode can be exited by pressing and holding the SW1 button for 2 to 5 seconds or by cycling the power. **NOTE:** Test mode will automatically be exited after 30 minutes.

Variable Speed ECM Configuration Mode

The control is placed in the ECM configuration mode by holding the pushbutton switch SW1 for 5 to 10 seconds, the high, low, and "G" ECM speeds can be selected by following the LED display lights. LED2 (yellow) will fast flash when entering the ECM configuration. When setting "G" speed LED3 (green) will be continuously lit, for low speed LED1 (red) will be continuously lit, and for high speed both LED3 (green) and LED1 (red) will be continuously lit. During the ECM configuration mode LED2 (yellow) will flash each of the 12 possible blower speeds 3 times. When the desired speed is flashed press SW1, LED2 will fast flash until SW1 is released. "G" speed has now been selected. Next select low speed, and high speed blower selections following the same process above. After third selection has been made, the control will exit the ECM configuration mode. Aux fan speed will remain at default or current setting and requires the AID Tool for adjustment.

Reset Configuration Mode

The control is placed in reset configuration mode by holding the push button switch SW1 for 50 to 60 seconds. This will reset all configuration settings and the EEPROM back to the factory default settings. LED3 (green) will turn off when entering reset configuration mode. Once LED3 (green) turns off, release SW1 and the control will reset.

DIP Switch (SW2)

- SW2-1** FP1 Selection - Low water coil temperature limit setting for freeze detection. On = 30°F; Off = 15°F.
- SW2-2** FP2 Selection - On = 30°F; Off = N/A
- SW2-3** RV - O/B - thermostat type. Heat pump thermostats with "O" output in cooling or "B" output in Heating can be selected. On = O; Off = B.
- SW2-4 and 2-5** Access Relay Operation (P2)

Access Relay Operation	SW2-4	SW2-5
Cycle with Blower	ON	ON
Cycle with Compressor	OFF	OFF
Water Valve Slow Opening	ON	OFF
Cycle with Comm. T-stat Hum Cmd	OFF	ON

Aurora Control System

Cycle with Blower - The accessory relay will cycle with the blower output.

Cycle with Compressor - The accessory relay will cycle with the compressor output.

Water Valve Slow Opening - The accessory relay will cycle and delay both the blower and compressor output for 90 seconds.

SW2-6 CC Operation - selection of single or dual capacity compressor. On = Single Stage; Off = Dual Capacity

SW2-7 Lockout and Alarm Outputs (P2) - selection of a continuous or pulsed output for both the LO and ALM Outputs. On = Continuous; Off = Pulsed

SW2-8 *Future Use*

Alarm Jumper Clip Selection

From the factory, ALM is connected to 24 VAC via JW2. By cutting JW2, ALM becomes a dry contact connected to ALG.

Variable Speed ECM Blower Speeds

The blower speeds can be changed either by using the ECM manual configurations mode method or by using the Aurora AID Tool directly (see Instruction Guide: Aurora Interface and Diagnostics (AID) Tool topic).

Field Selectable Options via Software

(Selectable via the Aurora AID Tool)

Variable Speed ECM Blower Speeds

An ECM blower motor can be driven directly using the onboard PWM output. Four blower speeds are available, based upon the "G", Y1 (low), Y2 (high), and Aux input signals to the board. The blower speeds can be changed either by the ECM manual configurations mode method (see ECM Configuration Mode topic) or by using the Aurora AID Tool directly. All four blower speeds can be set to the same speed if desired. Aux blower speed will remain at default or current setting and requires the AID Tool for adjustment.

Safety Features

The following safety features are provided to protect the compressor, heat exchangers, wiring and other components from damage caused by operation outside of design conditions.

Fuse - a 3 amp automotive type plug-in fuse provides protection against short circuit or overload conditions.

Anti-Short Cycle Protection - 4 minute anti-short cycle protection for the compressor.

Random Start - 5 to 80 second random start upon power up.

Fault Retry - in the fault condition, the control will stage off the outputs and then "try again" to satisfy the thermostat Y input call. Once the thermostat input calls are satisfied, the control will continue on as if no fault occurred. If 3 consecutive faults occur without satisfying the thermostat Y input call, then the control will go to Lockout mode.

Lockout - when locked out, the blower will operate continuously in "G" speed. The Alarm output (ALM) and Lockout output (L) will be turned on. The fault type identification display LED1 (Red) shall flash the fault code. To reset lockout conditions with SW2-8 On, thermostat inputs "Y1", "Y2", and "W" must be removed for at least 3 seconds. To reset lockout conditions with SW2-8 Off, thermostat inputs "Y1", "Y2", "W", and "DH" must be removed for at least 3 seconds. Lockout may also be reset by turning power off for at least 30 seconds or by enabling the emergency shutdown input for at least 3 seconds.

Lockout With Emergency Heat - if the control is locked out in the heating mode, and a Y2 or W input is received, the control will operate in the emergency heat mode while the compressor is locked out. The first emergency heat output will be energized 10 seconds after the W input is received, and the blower will shift to high speed. If the control remains locked out, and the W input is present, additional stage of emergency heat will stage on after 2 minutes. When the W input is removed, all of the emergency heat outputs will turn off, and the ECM blower will shift to "G" speed.

High Pressure - fault is recognized when the Normally Closed High Pressure Switch, P4-9/10 opens, no matter how momentarily. The High Pressure Switch is electrically in series with the Compressor Contactor and serves as a hard-wired limit switch if an overpressure condition should occur.

Low Pressure - fault is recognized when the Normally Closed Low Pressure Switch, P4-7/8 is continuously open for 30 seconds. Closure of the LPS any time during the 30 second recognition time restarts the 30 second continuous open requirement. A continuously open LPS shall not be recognized during the 2 minute startup bypass time.

Loss of Charge - fault is recognized when the Normally Closed Low Pressure Switch, P4-7/8 is open prior to the compressor starting.

Condensate Overflow - fault is recognized when the impedance between this line and 24 VAC common or chassis ground drops below 100K ohms for 30 seconds continuously.

Freeze Detection (Coax) - set points shall be either 30°F or 15°F. When the thermistor temperature drops below the selected set point, the control shall begin counting down the 30 seconds delay. If the thermistor value rises above the selected set point, then the count should reset. The resistance value must remain below the selected set point for the entire length of the appropriate delay to be recognized as a fault. This fault will be ignored for the initial 2 minutes of the compressor run time.

Freeze Detection (Air Coil) - uses the FP2 input to protect against ice formation on the air coil. The FP2 input will operate exactly like FP1 except that the set point is 30 degrees and is not field adjustable.

Aurora Control System

Over/Under Voltage Shutdown - An over/under voltage condition exists when the control voltage is outside the range of 18 VAC to 30 VAC. If the over/under voltage shutdown lasts for 15 minutes, the lockout and alarm relay will be energized. Over/under voltage shutdown is self-resetting in that if the voltage comes back within range of 18 VAC to 30 VAC for at least 0.5 seconds, then normal operation is restored.

Operation Description

Power Up - The unit will not operate until all the inputs and safety controls are checked for normal conditions. The unit has a 5 to 80 second random start delay at power up. Then the compressor has a 4 minute anti-short cycle delay after the random start delay.

Standby In standby mode, Y1, Y2, W, DH, and G are not active. Input O may be active. The blower and compressor will be off.

Heating Operation

Heating, 1st Stage (Y1) - The blower is started on “G” speed immediately and the compressor is energized 10 seconds after the Y1 input is received. The ECM blower motor is switched to low speed 15 seconds after the Y1 input.

Heating, 2nd Stage (Y1, Y2) - The compressor will be staged to full capacity 20 seconds after Y2 input is received. The ECM blower will shift to high speed 15 seconds after the Y2 input is received.

Heating, 3rd Stage (Y1, Y2, W) - The hot water pump is de-energized and the first stage of electric heat is energized 10 seconds after the W command is received. If the demand continues the second stage of electric heat will be energized after 5 minutes.

Emergency Heat (W) - The blower will be started on “G” speed, 10 seconds later the first stage of electric heat will be turned on. 5 seconds after the first stage of electric heat is energized the blower will shift to Aux speed. If the emergency heat demand is not satisfied after 2 minutes the second electric heat stage will be energized.

Blower (G) - The blower will start immediately upon receiving a thermostat G command. If there are no other commands from the thermostat the ECM will run on “G” speed until the G command is removed. Regardless of blower input (G) from the thermostat, the blower will remain on for 30 seconds at the end of each heating cycle.

Cooling Operation

In all cooling operations, the reversing valve directly tracks the O input. Thus, anytime the O input is present, the reversing valve will be energized.

Cooling, 1st Stage (Y1, O) - The blower is started on “G” speed immediately and the compressor is energized 10 seconds after the Y1 input is received. The ECM blower motor is switched to low speed 15 seconds after the Y1 input.

Cooling, 2nd Stage (Y1, Y2, O) - The compressor will be staged to full capacity 20 seconds after Y2 input is received. The ECM blower will shift to high speed 15 seconds after the Y2 input is received.

Blower (G) - The blower will start immediately upon receiving a thermostat G command. If there are no other commands from the thermostat the ECM will run on “G” speed until the G command is removed. Regardless of blower input (G) from the thermostat, the blower will remain on for 30 seconds at the end of each heating, cooling, and emergency heat cycle.

Dehumidification (Y1, O, DH or Y1, Y2, O, DH) - When a DH command is received from the thermostat during a compressor call for cooling the ECM blower speed will be reduced by 15% to increase dehumidification.

Emergency Shutdown - Four (4) seconds after a valid ES input, P2-7 is present, all control outputs will be turned off and remain off until the emergency shutdown input is no longer present. The first time that the compressor is started after the control exits the emergency shutdown mode, there will be an anti-short cycle delay followed by a random start delay. Input must be tied to common to activate.

Continuous Blower Operation - The blower output will be energized any time the control has a G input present, unless the control has an emergency shutdown input present. The blower output will be turned off when G input is removed.

Load Shed - The LS input disables all outputs with the exception of the blower output. When the LS input has been cleared, the anti-short cycle timer and random start timer will be initiated. Input must be tied to common to activate.

Hydronic

Hydronic Mode

If the Hydronic demand is active, either with no forced air demand present or with priority over forced air operation, the system will operate in hydronic mode. In hydronic mode the solenoid and reversing valve outputs will be off, and the diverting valve output will be active. When the Hydronic demand is recognized, assuming the compressor ASCD is satisfied the load and source side loop pumps are activated and the solenoid valve is deactivated. The compressor is also activated at full capacity when the pumps are activated. If the reversing valve is active from previous cooling operation, it will be deactivated when the compressor is activated. The diverting valve will be activated 8 seconds after the compressor. If a DHW demand is present and the operating conditions permit, the DHW pump output will be active with the compressor output. When the Hydronic demand is removed, the compressor and pump outputs are deactivated immediately.

Aurora Control System

Hydronic Pump Sampling

The hydronic controller uses two sensor inputs, the thermistor supplied in the Geo-Storage Tank and the thermistor supplied on the entering load water line of the heat pump, to operate load pump sampling and the heat pump. The tank sensor must be field wired to the AXB2 control board P17 connection. Once a set point temperature is selected it will be monitored by the entering load water temperature sensor (ELWT). The ELWT sensor is factory installed on the entering load water line of the heat pump. The second sensor, the Geo-Storage Tank sensor will be used to initiate a pump sample. When the Geo-Storage Tank sensor is outside the set point temperature + or - the deadband, based on whether heating or cooling, a pump sample will be initiated. The load pump sampling will operate for a field selectable time of 2, 3 or 4 minutes (default of 3 minutes) to sample the ELWT. At the end of the sampling period the ELWT is measured to determine if the ELWT is outside the set point + or - the deadband. If the ELWT is outside the set point + or - the deadband then the compressor is energized, and the load pump continues to operate. If after sampling the ELWT, the temperature is within the set point + or - the deadband then pump sampling is terminated until the Geo-Storage Tank sensor drops another 5°F where sampling is initiated again.

Outdoor Reset

This control mode uses the outdoor reset algorithm to continuously monitor and the outdoor temperature and adjust the tank set point every 30 minutes. The set up menu allows selection of Maximum Tank Temperature at a corresponding outdoor air temperature (OAT), and Minimum Tank Temperature at its corresponding OAT. A field installed outdoor temperature sensor will need to be connected to the LAT connection on the AXB2 control board.

If Outdoor Reset operation is enabled and there is a valid outdoor temperature value available from the outdoor sensor the Outdoor Reset logic will be operational. When Outdoor Reset is operational, the effective hydronic heating setpoint will be adjusted between the Hydronic Heating Setpoint setting and the Outdoor Reset Minimum Setpoint value based on the current OAT value. If the OAT is less than or equal to the Outdoor Reset OAT Maximum Setpoint value, the effective hydronic heating setpoint will be the Hydronic Heating Setpoint value. If the OAT is greater than or equal to the Outdoor Reset OAT Minimum Setpoint value, the effective hydronic heating setpoint will be the Outdoor Reset Minimum Setpoint value. If the OAT is between the Outdoor Reset OAT Maximum Setpoint value and the Outdoor Reset OAT Minimum Setpoint value, the effective hydronic heating setpoint will be adjusted linearly between the Hydronic Heating Setpoint value and the Outdoor Reset Minimum Setpoint value based on the current OAT value. To prevent erratic operation based on fluctuating temperatures or sensor readings, the OAT value used by the Outdoor Reset logic will be updated every 30 minutes rather than continuously.

Warm Weather Shutdown

If the warm weather shutdown is selected, the controller will check the outdoor air temperature sensor every 30 minutes. If the temperature is higher than the set temperature selected for 50 continuous hours, then the Hydronic controller will enter the warm weather shutdown mode. If the temperature drops below the selected setpoint for 5 continuous hours, the controller will exit the warm weather shutdown mode and return back to normal. Warm weather shutdown selections are None, 45, 50, 55, 60, and 65. The factory default is None.

Compressor Out of Envelope

While operating in hydronic mode the ABC controls will monitor the saturated discharge temperature (SDT) and where that temperature is on the compressor operating envelop map. If the SDT is outside the compressor envelope map, the tank temperature setpoint will be reduced by 5°F. This cycle will repeat until the SDT returns to inside the compressor operating map. If the effective hydronic heating setpoint has already been reduced to the minimum value of 90°F and the SDT is still outside the operating map for more than 30 seconds, instead of reducing the setpoint further, a high SDT fault will be recognized, and the system will shut down for a fault retry period. If this occurs three times during the same hydronic demand without the effective setpoint being adjusted, hydronic operation will be locked out due to high saturated discharge temperature, or compressor out of envelope operation, indicated by the E-55 fault code. The E-55 compressor out of envelope indicator will be available at the thermostat and on Symphony to indicate that hydronic operation is using a reduced setpoint. If the system is operating with a reduced effective hydronic heating setpoint and the system has raised the water temperature to satisfy the reduced setpoint while operating at full load and the current SDT is back inside the operating map, the effective hydronic heating setpoint will be increased by 1°F and hydronic operation will continue. This process may be repeated during a single hydronic demand cycle or during multiple cycles.

AXB Control Board

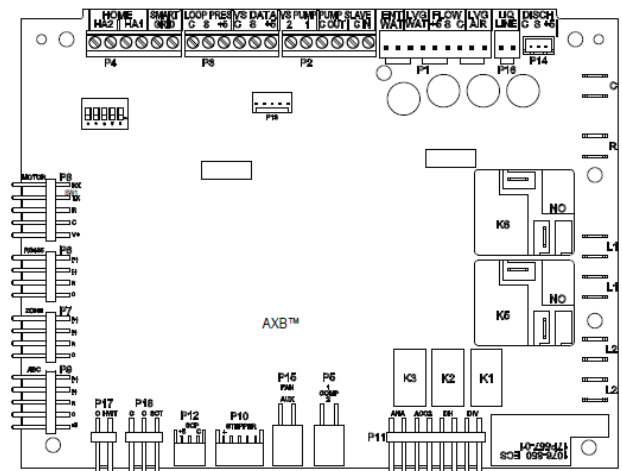

Aurora Control System

Aurora ‘Advanced’ Control Features

The Aurora ‘Advanced’ Control system expands on the capability of the Aurora ‘Base’ Control (ABC) by adding the Aurora Expansion Board (AXB). All of the preceding features of the Aurora ‘Base’ Control are included. The following control description is of the additional features and capability of the Aurora advanced control.

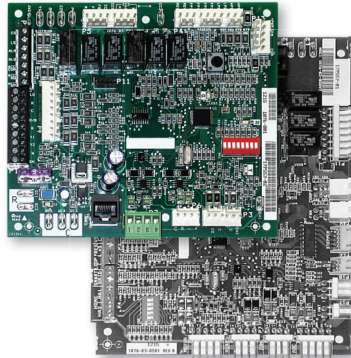

It is highly recommended the installing/servicing contractor obtain an Aurora Interface and Diagnostic Tool (AID) and specialized training before attempting to install or service an Aurora ‘Advanced’ control system.



The additional AXB features include the following:

AXB1 DIP Switch

AXB2 DIP Switch

DIP 1 - ID: This is the AXB ModBus ID and should always read Off.

DIP 2 & 3 - Future Use

DIP 4 & 5 - Accessory Relay2: A second, DIP configurable, accessory relay is provided that can be cycled with the compressor 1 or 2, blower, or the Dehumidifier (DH) input. This is to complement the Accessory 1 Relay on the ABC board.

Position	DIP 4	DIP 5	Description
1	ON	ON	Cycles with Fan or ECM (or G)
2	OFF	ON	Cycles with CC1 first stage of compressor or compressor spd 1-6
3	ON	OFF	Cycles with CC2 second stage of compressor or compressor spd 7-12
4	OFF	OFF	Cycles with DH input from ABC board

Advanced Hot Water Generator Control AXB1 (Domestic Hot Water Option)

In lieu of the ‘Base Hot Water Generator Control’, the Advanced features an AID Tool selectable temperature limit and microprocessor control of the process. This will maximize hot water generation and prevent undesirable energy use. An alert will occur when the hot water input temperature is at or above setpoint (100°F - 140°F) for 30 continuous seconds (130°F is the default setting). This alert will appear as an E15 on the AID Tool and the hot water pump de-energizes. Hot water pump operations resume on the next compressor cycle

or after 15 minutes of continuous compressor operation during the current thermostat demand cycle. Since compressor hot gas temperature is dependent on loop temperature in cooling mode, loop temperatures may be too low to allow proper heating of water. The control will monitor water and refrigerant temperatures to determine if conditions are satisfactory for heating water. LED1 (red LED) will flash code 15 when the DHW limit is reached and when conditions are not favorable for water heating. Error code 15 will also be displayed on the AID Tool in the fault screen. This flash code is a noncritical alert and does not necessarily indicate a problem.

Compressor Monitoring AXB1

The AXB includes two current transducers to monitor the compressor current and starting characteristics. Open circuits or welded contactor faults will be detected. A fault will produce an E10 code.

IntelliZone2 Zoning Compatibility (Future) (Optional IntelliZone2 Communicating Zoning)

A dedicated input to connect and communicate with the IntelliZone2 (IZ2) zoning system is provided on P7 on the AXB. This is a dedicated communication port using a proprietary ModBus protocol. An AXB is required. Consult the IntelliZone2 literature for more information.

AWL - Aurora Weblink

(optional accessory)

AWL is an add-on WiFi router that connects to the ABC and offers many features:

- Remote access to thermostat settings, schedules, etc. with your smartphone, tablet or laptop
- Receive Lockout/Fault info via text or e-mail
- View heat pump energy usage from the Internet for the day, week, month, year or real-time
- Internet AID Tool capability allows remote troubleshooting for the technician
- Remote AID Tool capability at the heat pump with smartphone, tablet or laptop for the technician
- Allows data acquisition of the heat pump through the Internet, see graphs of performance and chart historical data for the technician
- Stores historical data on SD card

Variable Speed Pump AXB1

This input and output are provided to drive and monitor a variable speed pump. The VS pump output is a PWM signal to drive the variable speed pump. The minimum and maximum level are set using the AID Tool. 75% and 100% are the default settings respectively. The VS data input allows a separate PWM signal to return from the pump giving fault and performance information. Fault received from the variable speed pump will be displayed as E16.

Aurora Control System

Aurora 'Base' Control LED Displays

These three LEDs display the status, configuration, and fault codes for the control. These can also be read in plain English via the Aurora AID Tool.

Status LED (LED3, Green)

Description of Operation	Fault LED, Green
Normal Mode	ON
Control is Non-functional	OFF
Test Mode	Slow Flash
Lockout Active	Fast Flash
Dehumidification Mode	Flash Code 2
(Future Use)	Flash Code 3
(Future Use)	Flash Code 4
Load Shed	Flash Code 5
ESD	Flash Code 6
(Future Use)	Flash Code 7

Configuration LED (LED2, Yellow)

Description of Operation	Configuration LED, Yellow
No Software Overwritten	Flashing ECM Setting
DIP Switch was Overwritten	Slow Flash
ECM Configuration Mode	Fast Flash

Fault LED (LED1, Red)

	Red Fault LED	LED Flash Code*	Lockout	Reset/Remove
ABC Basic Faults	Normal - No Faults	OFF	-	
	Fault - Input	1	No	Auto
	Fault - High Pressure	2	Yes	Hard or Soft
	Fault - Low Pressure	3	Yes	Hard or Soft
	Fault - Freeze Detection FP2	4	Yes	Hard or Soft
	Fault - Freeze Detection FP1	5	Yes	Hard or Soft
	Fault - Condensate Overflow	7	Yes	Hard or Soft
	Fault - Over/Under Voltage	8	No	Auto
	Fault - FP1 Sensor Error	11	Yes	Hard or Soft
	Fault - CritComErr	19	NO	Auto

NOTE: All codes >11 use long flash for tens digit and short flash for the ones digit. 20, 30, 40, 50, etc. are skipped.

ASB Sensor Board

Refrigerant Leak Detection

The Aurora control system uses the ASB control board to monitor the refrigerant sensor and determine when a fault condition requiring mitigation has been recognized and is active.

The ASB control will provide the indicator for an active refrigerant leak condition requiring mitigation in addition to the currently measured refrigerant level in ppm for each sensor connected to the ASB.

Refrigerant Leak Mitigation

If the refrigerant sensor detects a leak, the ASB board will communicate the leak detection to the ABC control board. The ABC will deactivate the compressor, auxiliary heat and pump outputs. The system's blower will come on, and the system will continue to operate in this state until the ABC is no longer reporting a fault condition.

ASB Control Board

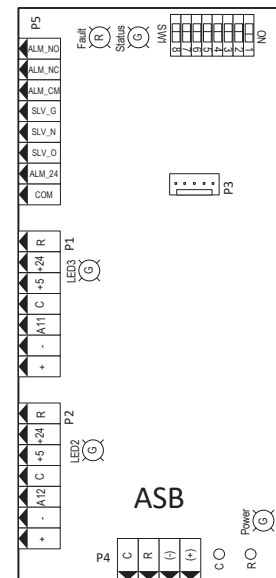

ABC Control Board Layout

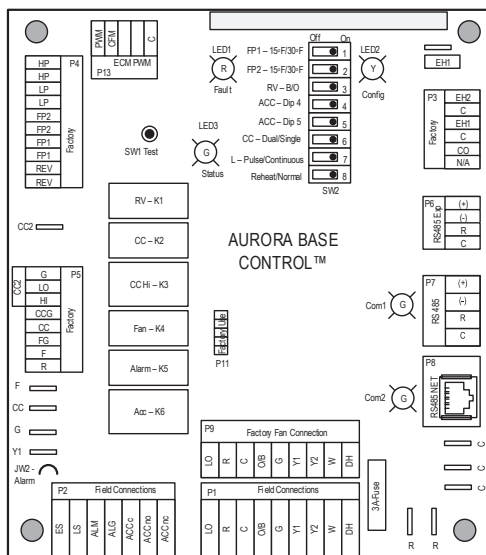

Aurora Interface and Diagnostics (AID) Tool

The Aurora Interface and Diagnostics (AID) Tool is a device that is a member of the Aurora network. The AID Tool is used to troubleshoot equipment which uses the Aurora control via Modbus RTU communication. The AID Tool provides diagnostics, fault management, variable speed ECM setup, and system configuration capabilities to the Aurora family of controls. An AID Tool is recommended, although not required, for ECM airflow settings. The AID Tool simply plugs into the exterior of the cabinet in the AID Tool port.



Aurora Control System

Aurora Contractor Connect and Symphony Contractor Connect

Optional accessory

The Symphony Contractor Connect (SCC) brings ground source heat pump data and troubleshooting to your fingertips. Symphony Contractor Connect with the use of the Aurora Contractor Connect (ACC) replaces the current AID Tool. This app provides an enhanced and more efficient experience for the service technician in assessing system performance and component troubleshooting. REQUIRES dealer login credentials SCC is for dealer technicians ONLY and includes:

- AID Tool
- Technical Literature lookup
- Troubleshooting videos
- Step by Step AWL Setup and Configuration to Home Router
- Methodical approach to assist in diagnostics
- Perform routine installation chart reading and calculations
- Electronic capture of Start-Up Documentation
- Active Charge Assist and Charge Calculator for split systems



Modulating Water Valve AXB1

This output is provided to drive a modulating water valve. Through advanced design the 0-10VDC valve can be driven directly from the VS pump output. The minimum and maximum level are set in the same way as the VS pump using the AID Tool. 75% and 100% are the default settings respectively.

Loop Pump Linking AXB1

This input and output are provided so that two units can be linked together with a common flow center. When either unit has a call for loop pump, both unit's loop pump relays and variable speed pumps are energized. The flow center then can simply be wired to either unit. The output from one unit should be routed to the input of the other. If daisy chained up to 16 heat pumps can be wired and linked together in this fashion.

Advanced Communication Ports

Communication ports P6 and P8 will provide future expansion via dedicated protocols. These are for future use.

Smart Grid-On Peak (SG) Input

The 'On Peak' input was designed to allow utilities to utilize simple radio controlled switches to control the On Electric Peak behavior of the Geothermal Heat Pumps. With a closed contact signal, this input will limit the operation and thus the power consumption of the unit by one of the below selections. The AID Tool will allow configuration of this input for the action of:

- No Action
- Disable compressor operation until removed
- Go to On Peak thermostat settings until removed [Requires Com T-Stat] (Future Release)
- Compressor limited to 50% or low cap until removed [dual capacity or variable speed only] (Future Release)
- Disable compressor operation for 1/2 hr (can be removed immediately) (Future Release)

Then Flash Code 7 on the Green LED for the 'On Peak' mode. And On Peak will display on communicating thermostats.

Home Automation 1 and 2 Inputs

The Home automation inputs are simple closed contact inputs that will trigger an AID Tool and thermostat alert for the homeowner. These would require optional sensors and or equipment for connection to the AXB board. With two inputs two different sensors can be selected. The selected text will then be displayed on the AID Tool and communicating thermostats. These events will NOT alter functionality or operation of the heat pump/accessories and is for homeowner/service notification only.

Home Automation 1 - E23 HA1 AXB1

With a closed dry contact signal, this input will cause an alarm and Alert Code 23 to indicate on the stat or flash on ABC. The AID Tool will allow configuration of this input between the following selections:

- No Action
- Home Automation Fault [no lockout info only]
 - Output from home automation system
- Security Alarm [no lockout info only]
 - Output from home security
- Sump Alarm Fault [no lockout info only]
 - Switch output from sump sensor
- Smoke/CO Alarm Fault [no lockout info only]
 - Switch output from Smoke/CO sensor
- Dirty Filter Alarm [no lockout info only]
 - Output from dirty filter sensor

Aurora Control System

Home Automation 2 - E24 HA2 AXB1

With a closed dry contact signal, this input will cause an alarm and Alert Code 24 to indicate on the stat or flash on ABC. The AID Tool will allow configuration of this input between the following selections:

- No Action
- Home Automation Fault [no lockout info only]
 - Output from home automation system
- Security Alarm [no lockout info only]
 - Output from home security
- Sump Alarm Fault [no lockout info only]
 - Switch output from sump sensor
- Smoke/CO Alarm Fault [no lockout info only]
 - Switch output from Smoke/CO sensor
- Dirty Filter Alarm [no lockout info only]
 - Output from dirty filter sensor

Monitoring Sensor Kits

Energy Monitoring

The Energy Monitoring Kit includes two current transducers (blower and electric heat) added to the existing two compressor sensors so that the complete power usage of the heat pump can be measured. The AID Tool provides configuration detail for the type of blower motor, power adjustment and a line voltage calibration procedure to improve the accuracy, and a power adjustment setting that allows the compressor power to be adjusted to match the unit's line voltage using the provided tables. This information can be displayed on the AID Tool or selected communicating thermostats. The communicating thermostat will display instantaneous energy use and display a 13 month history in graph form. Refer to Unit Start Up Energy Monitoring for configuration details.

Dual Capacity Power Adjustment

Model	Unit Capacity	Voltage		
		208	230	250
036	Full Load	0.99	0.97	0.91
	Part Load	0.99	0.94	0.83
048	Full Load	0.94	0.91	0.85
	Part Load	0.91	0.84	0.75
060	Full Load	0.95	0.9	0.79
	Part Load	0.92	0.83	0.71
072	Full Load	0.94	0.86	0.73
	Part Load	0.92	0.81	0.65

Refrigerant Monitoring (standard sensor kit)

The AXB1 Refrigerant Monitoring Kit includes two pressure transducers, and three temperature sensors, heating liquid line, suction temperature and existing cooling liquid line (FP1). These sensors allow the measurement of discharge and suction pressures, suction and liquid line temperatures as well as superheat and subcooling. AXB2 kit includes a discharge temperature sensor. This information will only be displayed on the AID Tool.

Performance Monitoring (standard sensor kit) AXB1

The Performance Monitoring Kit includes three temperature sensors, entering and leaving source water, leaving air temperature and a source water flow rate sensor. With this kit heat of extraction and rejection will be calculated. This requires configuration using the AID Tool for selection of water or antifreeze.

Performance Monitoring (standard sensor kit) AXB2

The performance Monitoring Kit includes two temperature sensors, entering and leaving load temperature and a load side water flow rate sensor. With this kit the load side heat of extraction can be calculated. This requires configuration using the AID Tool for selection of water or antifreeze.

Special Modes and Applications

Communicating Digital Thermostats

The Aurora controls system also features either mono-chromatic or color touch screen graphic display thermostats for user interface. These displays not only feature easy to use graphical interface but display alerts and faults in plain English. Many of the features discussed here may not be applicable without these thermostats.

Dehumidification - Passive

In passive dehumidification mode, the airflow is reduced by 15% from the heating airflow setting. If cooling airflow is set to +5, -5 or -10% of heating airflow it will automatically be set to -15% of heating airflow whenever the dehumidification call is present in the communicating stat or from the thermostat input DH. If the airflow for cooling is already set to -15% no airflow change will be noticed from normal cooling. Dehumidification mode will be shown on the ABC and the communicating thermostats.

Aurora 'Advanced' Control LED Displays

These three LEDs display the status, configuration, and fault codes for the control. These can also be read in plain English via the Aurora AID Tool.

Status LED (LED3, Green)

Description of Operation	Fault LED, Green
Normal Mode	ON
Control is Non-functional	OFF
Test Mode	Slow Flash
Lockout Active	Fast Flash
Dehumidification Mode	Flash Code 2
Load Shed	Flash Code 5
Emergency Shutdown	Flash Code 6
On Peak Mode	Flash Code 7
(Future Use)	Flash Code 8
(Future Use)	Flash Code 9

Configuration LED (LED2, Yellow)

Description of Operation	Configuration LED, Yellow
No Software Overwritten	ECM Setting
DIP Switch Overwritten	Slow Flash
ECM Configuration Mode	Fast Flash
Reset Configuration Mode	OFF

Aurora Control System

Fault LED (LED1, Red)

	Red Fault LED	LED Flash Code*	Lockout	Reset/ Remove	Fault Condition Summary
ABC & AXB Basic Faults	Normal - No Faults	Off			
	Fault-Input	1	No	Auto	Tstat input error. Autoreset upon condition removal.
	Fault-High Pressure	2	Yes	Hard or Soft	HP switch has tripped (>600 psi)
	Fault-Low Pressure	3	Yes	Hard or Soft	Low Pressure Switch has tripped (<40 psi for 30 continuous sec.)
	Fault-Freeze Detection FP2	4	Yes	Hard or Soft	Freeze protection sensor has tripped (<15 or 30 degF for 30 continuous sec.)
	Fault-Freeze Detection FP1	5	Yes	Hard or Soft	Freeze protection sensor has tripped (<15 or 30 degF for 30 continuous sec.)
	Fault-Loss of Charge	6	Yes	Hard or Soft	Low Pressure Switch open prior to compressor start (UPC Only)
	Fault-Condensate Overflow	7	Yes	Hard or Soft	Condensate switch has shown continuity for 30 continuous sec.
	Fault-Over/Under Voltage	8	No**	Auto	Instantaneous Voltage is out of range. **Controls shut down until resolved.
	Fault-Compressor Monitor	10	Yes	Hard or Soft	Open Crkt, Run, Start or welded cont
	Fault-FP1 & 2 Snsr Error	11	Yes	Hard or Soft	If FP1 or 2 Sensor Err
	Non-CriticAXBSnsrErr	13	No	Auto	Any Other Sensor Err
	CriticAXBSnsrErr	14	Yes	Hard or Soft	Sensor Err for EEV or HW
	Alarm-HotWtr	15	No	Auto	HW over limit or logic lockout. HW pump deactivated.
	Fault-VarSpdPump	16	No	Auto	Alert is read from PWM feedback.
	Non-CritComErr	18	No	Auto	Any non-critical com error
	Fault-CritComErr	19	No	Auto	Any critical com error. Auto reset upon condition removal
	Alarm - Low Loop Pressure	21	No	Auto	Loop pressure is below 3 psi for more than 3 minutes
	Alarm - Home Automation 1	23	No	Auto	Closed contact input is present on Dig 2 input - Text is configurable
	Alarm - Home Automation 2	24	No	Auto	Closed contact input is present on Dig 3 input - Text is configurable
Fault - AXB EEV Error	25	Yes	Auto	AXB EEV Error	
Ind/Pkg EEV2	Fault-High Load Water Temp	33	Yes	Auto	High Load Water Temperature: Enetreing Load Temperatures < 135°F
	Fault-High Discharge Temp	42	Yes	Auto	High Discharge Line Temperature: Discharge Line Temperature < 260°F
	Fault-SucPrsSnr	52	Yes	Auto	Suction Pressure (P _o) is invalid (0 to 232 psi)
	Fault-Compressor Out of Env	55	Yes	Hard or Soft	Compressor Out of Envelope
	Fault-LosofCharge	71	Yes	Hard or Soft	High superheat and high EEV opening % for a long time will trigger a loss of charge fault
	SafeMd-SucTmpSnr	72	No	Auto	Suction Temperature Sensor is invalid (-76 to 392 F)
	SafeMd-LATSensor	73	No	Auto	Leaving Air Temperature Sensor is invalid (-76 to 392 F)
SafeMd-MaxOpPres	74	No	Auto	Suction pressure has exceeded that maximum operating level for 90 sec.	
ASB	ASB High Gas Concentration	81	Yes	Auto	High refrigerant gas concentration detected by ASB and gas sensor.
	ASB Sensor Problem	82	Yes	Auto	Gas sensor has issued a fault, lost communication, internal error
	Invalid System Config	97	Yes	Auto	ABC has not been configured for Refrigerant type, disch pr sensor type, or suct press sens.

Note: *All codes >11 use long flash for tens digit and short flash for the ones digit. 20, 30, 40, 50 etc. will be skipped!

Alert' is a noncritical sensor or function that has failed. Normal operation of the heat pump is maintained but service is desired at some point.

Aurora Control System

Aurora now expands the Fault/Alarms in to several groups. Faults are system critical faults to the heat pump and will cause a Lockout. Some are retried 3 times before locking out while others lockout out immediately. Consult the Fault Retries table before lockout for details. Alarms are designed solely to alert the customer and the dealer to alarms designed as an input only to the Aurora system. These alarms are not system critical. Errors are sensor/hardware errors that although may not be system critical, may need serviced for optimal features.

SafeMode - the system is still operational during safemode.

Summary Table of Faults, Alarm, and Errors

All lockouts and alarms are shown in the Status LED (LED1, Red) table with the associated codes visible on the thermostat, ABC Fault LED, and in text in the AID Tool.

Aurora Fault Codes (ABC-Red LED)

These fault codes generally will affect the operation of the heat pump and will cause a lockout.

E1, Fault Input - A Y1/Y2 style thermostat is providing a non-normal sequence of signals possibly caused by a bad thermostat wire or connection.

E2, High Pressure - Fault is recognized when the Normally Closed High Pressure Switch, P4-9/10 opens, no matter how momentarily. The High Pressure Switch is electrically in series with the Compressor Contactor and serves as a hardwired limit switch if an overpressure condition should occur.

E3, Low Pressure - Fault is recognized when the Normally Closed Low Pressure Switch, P4-7/8 is continuously open for 30 seconds. Closure of the LPS any time during the 30 second recognition time restarts the 30 second continuous open requirement. A continuously open LPS shall not be recognized during the 2 minute startup bypass time.

E3, Loss of Charge - Fault is recognized when the Normally Closed Low Pressure Switch, P4-7/8 is open prior to the compressor starting.

E4, Freeze Detection-Air Coil - Air Coil Freeze Detection will use the FP2 input to protect against ice formation on the air coil. The FP2 input will operate exactly like FP1 except that the set point is 30 degrees and is not field adjustable.

E5, Freeze Detection-Coax - Set points shall be either 30°F or 15°F. When the thermistor temperature drops below the selected set point, the control shall begin counting down the 30 seconds delay. If the thermistor value rises above the selected set point, then the count should reset. The resistance value must remain below the selected set point for the entire length of the appropriate delay to be recognized as a fault. This fault will be ignored for the initial 2 minutes of the compressor run time.

E7, Condensate Overflow - Fault is recognized when the impedance between this line and 24 VAC common or chassis ground drops below 100K ohms for 30 seconds continuously.

E8, Over/Under Voltage Shutdown - An over/under voltage condition exists when the control voltage is outside the range of 18 VAC to 30 VAC. If the over/under voltage shutdown lasts for 15 minutes, the lockout and alarm relay will be energized. Over/under voltage shutdown is self-resetting in that if the voltage comes back within range of 18 VAC to 30 VAC for at least 0.5 seconds, then normal operation is restored.

E10, Compressor Monitoring - Fault is recognized when the compressor has an open circuit, potential welded contactor.

E11, FP1 Sensor Error - Fault is recognized when the impedance between this line and 24 VAC common or chassis.

E14, Critical AXB Sensor Error - Fault is recognized when a sensor faults that is critical to heat pump operation. These sensors would include the HW Temperature limit sensor.

E15, Alarm Hot Water - Fault is recognized when the hot water temperature sensor is either over the configured limit or the Aurora has determined the current conditions should disengage the hot water generation capability.

E16, Variable Speed Pump - Fault is recognized when the variable speed pump returns a fault code from its PWM feedback signal.

E19, Critical Communication Error - A critical communication error has occurred with a board that previously had been configured but now is not available for communication. Since this is critical to unit operation, the heat pump will be locked out with this fault displayed on the ABC board and the thermostat. The AID Tool should be used to view the configuration window and ascertain the status of all appropriate board communication. The fault displayed will be removed when the problem has been resolved or the unit is soft or hard reset.

E33, High Load Water Temperature - Fault is recognized when the entering load temperature exceeds 130°F.

E42, High Discharge Temperature - Fault is recognized when the compressor discharge line exceeds 260°F.

E52, Suction Pressure Invalid - The reading of the suction pressure transmitter is not within the specified sensor range of 0 to 16bar (0 to 232psi). Possible causes are faulty wiring or a defective transmitter.

E55, Compressor Out of Envelope - Fault is recognized when the saturated discharge line temperature (SDT) is outside the compressor envelope.

E81, ASB Leak Detected - The gas sensor has detected a leak. The ABS will communicate the leak to the ABC control board. Compressor and auxiliary heat will be deactivated, and blower will come on.

Aurora Control System

E82, ASB Sensor Problem - The gas sensor has lost communication with the ASB board or has an internal error.

E97, Invalid System Configuration - ABC has not been configured for sensor or refrigeration type.

Aurora Error Codes

NOTE: The system is operating normally, but a sensor or communication issue is preventing full features of the system. Since these can be deemed non-critical to system operation, such as internet access boards etc., they may simply cause errors/alerts that signal the user to the situation but may not effect normal operation.

E13, Non Critical AXB Sensor Error - Fault is recognized when a sensor faults that is not critical to heat pump operation. These sensors would include the performance, energy monitoring and refrigeration sensors.

E18, Error Non-Critical Communication Error - A non-critical communication error has occurred such as communication to the internet access board. Since this is not critical to unit operation, the heat pump will continue operating normally with this error displayed on the ABC board and the thermostat. The AID Tool should be used to view the configuration window and ascertain the status of all appropriate board communication. The Error displayed will be removed when the problem has been resolved.

Aurora SafeMode Codes

NOTE: The system is still operational during safemode. It is possible for some situations to progress from Derating to SafeMode to finally locking out due to a fault.

E72, SafeMode EEV - Suction Temperature Invalid - The reading of the suction temperature sensor is not within the specified sensor range of -60 to +200°C (-76 to +392°F). The EEV will be positioned at 50%. Possible causes are faulty wiring or a defective sensor.

E73, SafeMode EEV - Leaving Air Temperature (LAT) Invalid - The reading of the leaving air temperature sensor is not within the specified sensor range of -60 to +200°C (-76 to +392°F). Normal operation will continue with an Error 73 display on the thermostat to notify the user of the issue. Possible causes are faulty wiring or a defective sensor. The Error displayed will be removed when the problem has been resolved.

E74, SafeMode EEV - Maximum Operating Pressure (MOP)

- The reading of the suction pressure is above the recommended limit. If this condition persists more than 90 seconds, the Drive will revert to a Fault - Out of Envelope Code 35.

Aurora Alarm Codes

These alarms are planned to alert the homeowner and the service personnel but will NOT effect system operation and are for information only. These would be available on the thermostat, AID Tool and the internet access for remote monitoring capability.

E21, Loop Pressure Alarm - Fault is recognized when the loop pressure sensor is installed and the loop pressure falls below the setpoint.

E23 and E24, Home Automation 1 and 2 Inputs - The Home automation inputs are simple 24VAC inputs that will trigger an AID Tool and thermostat alert for the homeowner. These would require optional sensors and or equipment for connection to the AXB board. With two inputs, two different sensors can be selected. The selected text will then be displayed on the AID Tool and com thermostats. These events will NOT alter functionality or operation of the heat pump/accessories and is for homeowner/service notification only. With a closed dry contact signal, this input will cause an alarm E23 or E24 to indicate on the stat or flash on ABC. The AID Tool will allow configuration of these two inputs independently between the following selections:

- *No Action*
- *Home Automation Fault [no lockout, info only]* - Output from home automation system

Refrigerant Circuit Guideline

Symptom	Head Pressure	Suction Pressure	Compressor Amp Draw	Superheat	Subcooling	Air Temp. Differential	Water Temp. Differential
Under Charged System (Possible Leak)	Low	Low	Low	High	Low	Low	Low
Over Charged System	High	High	High	Normal	High	Normal/Low	Normal
Low Air Flow Heating	High	High	High	High/Normal	Low	High	Low
Low Air Flow Cooling	Low	Low	Low	Low/Normal	High	High	Low
Low Water Flow Heating	Low/Normal	Low/Normal	Low	Low	High	Low	High
Low Water Flow Cooling	High	High	High	High	Low	Low	High
High Air Flow Heating	Low	Low	Low	Low	High	Low	Low
High Air Flow Cooling	Low	High	Normal	High	Low	Low	Normal
High Water Flow Heating	Normal	Low	Normal	High	Normal	Normal	Low
High Water Flow Cooling	Low	Low	Low	Low	High	Normal	Low
Low Indoor Air Temperature Heating	Low	Low	Low	Normal	High	Normal	Normal/High
Low Indoor Air Temperature Cooling	Low	Low	Low	Normal/Low	High	Low	Low
High Indoor Air Temperature Heating	High	High	High	Normal/High	Normal/Low	Low	Normal
High Indoor Air Temperature Cooling	High	High	High	High	Low	Low	High
Restricted TXV (Check Service Advisory)	High	Low	Normal/Low	High	High	Low	Low
Insufficient Compressor (Possible Bad Valves)	Low	High	Low	High	Normal/High	Low	Low
TXV - Bulb Loss of Charge	Low	Low	Low	High	High	Low	Low
Scaled Coaxial Heat Exchanger Heating	Low	Low	Low	Normal/Low	High	Low	Low
Scaled Coaxial Heat Exchanger Cooling	High	High	High	Normal/Low	Low	Low	Low
Restricted Filter Drier	Check temperature difference (delta T) across filter drier.						

Electrical Information

WARNING

During repairs to sealed components, all electrical supplies shall be disconnected from the equipment being worked upon prior to any removal of sealed covers, etc. If it is absolutely necessary to have an electrical supply to equipment during servicing, then a permanently operating form of leak detection shall be located at the most critical point to warn of a potentially hazardous situation.

Sealed electrical components shall be replaced.

WARNING

Do not apply any permanent inductive or capacitance loads to the circuit with out ensuring that this will not exceed the permissible voltage and current permitted for the equipment in use.

Intrinsically safe components must be replaced.

Replace components only with parts specified by the manufacturer. Other parts may result in the ignition of refrigerant in the atmosphere from a leak.

NOTE The use of silicon sealant can inhibit the effectiveness of some types of leak detection equipment. Intrinsically safe components do not have to be isolated prior to working on them.

General

Be sure the available power is the same voltage and phase as that shown on the unit serial plate. Line and low voltage wiring must be done in accordance with local codes or the National Electric Code, whichever is applicable.

Unit Power Connection

Connect the incoming line voltage wires to L1 and L2 of the contactor as shown in Figure 13C for single-phase unit. Consult the unit's serial plate data for correct fuse sizes.

NOTE: A disconnection must be incorporated in the fixed wiring in accordance with the wiring rules/NEC.

Open lower front access panel. Remove ground fastener from bottom of control box (Figure 13B). Swing open control box (Figure 13A). Insert power wires through knockouts on lower left side of cabinet. Route wires through left side of control box and connect to contactor and ground (Figure 13C). Close control box and replace grounding fastener before unit start-up.

Accessory Relay

A set of "dry" contacts has been provided to control accessory devices, such as water solenoid valves on open loop installations, electronic air cleaners, humidifiers, etc. This relay contact should be used only with 24 volt signals and not line voltage power. The relay has both normally open and normally closed contacts and can operate with either the fan or the compressor. Use DIP switch SW2-4 and 5 to cycle the relay with blower, compressor, or control a slow opening water valve. The relay contacts are available on terminals #1 and #3 for normally closed, and #2 and #3 for normally open on P2.

A second configurable accessory relay is provided on the AXB board, if installed. When powering high VA draw components such as electronic air cleaners or V type open loop water valves, R should be taken 'pre-fuse' from the 'R' quick connect on the ABC board and not the 'post-fuse' 'R' terminal on the thermostat connection. If not, blown ABC fuses might result.

208 Volt Operation

All 208/230 units are factory wired for 230 volt operation. For 208 volt operation, the red and blue transformer wires must be switched on terminal strip PB2.

Pump Power Wiring

FC1/FC2 style flow centers with fixed speed pumps connect to PB1 in the control box. If using a variable speed pump it should be connected to L1 and L2 on the AXB.

Electrical Information

Figure 13A:
Wire access (control box open)

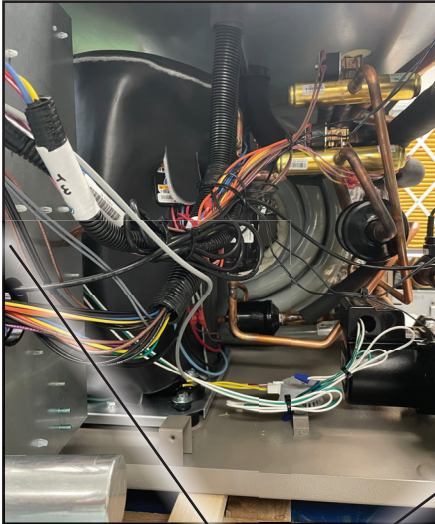

Wire Insert Location

Figure 13B:
Wire access (control box closed)



Ground Fastener must be installed for proper unit ground

Figure 13C:
Line Voltage 208-230/60/1 control box

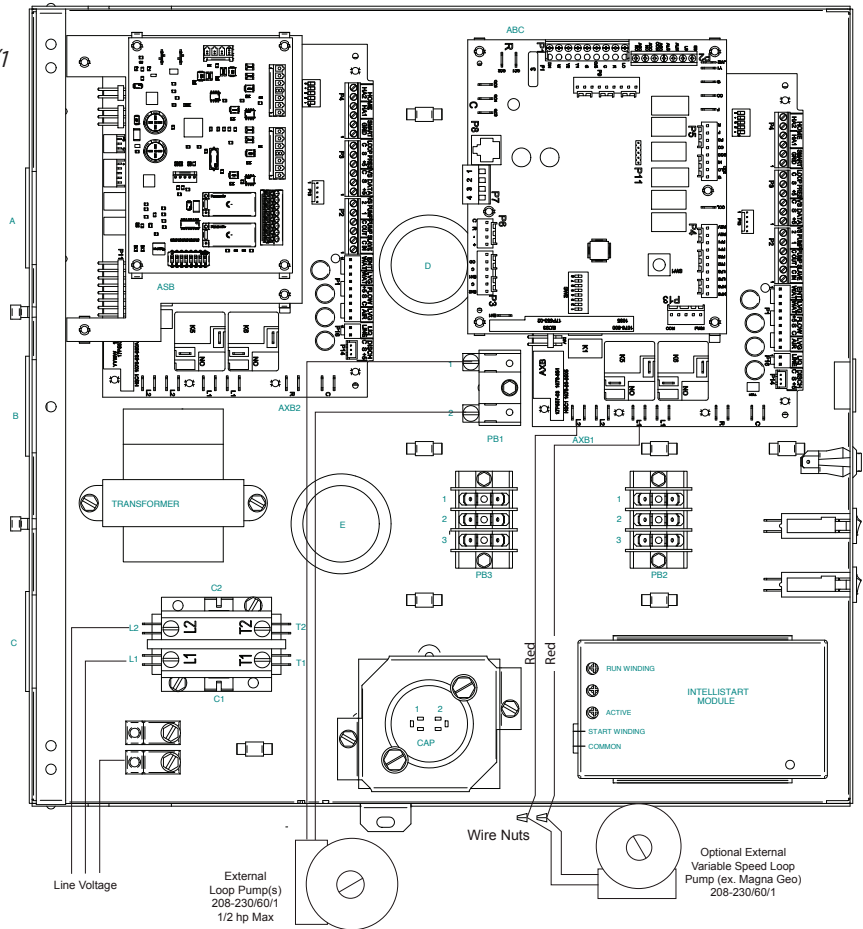

Electronic Thermostat Installation

Position the thermostat subbase against the wall so that it is level and the thermostat wires protrude through the middle of the subbase. Mark the position of the subbase mounting holes and drill holes with a 3/16-inch bit. Install supplied anchors and secure base to the wall. Thermostat wire must be 4 or 5 conductor for communicating thermostats, 20-AWG (minimum) wire. Shielded communication cable is recommended. Strip the wires back 1/4-inch (longer strip lengths may cause shorts) and insert the thermostat wires into the P7 connector as shown. Tighten the screws to ensure secure connections. The thermostat may have either screw or spring clip connectors, requiring the same wiring. **See instructions enclosed in the thermostat for detailed installation and operation information.**

Figure 22: Thermostat Wiring (Communicating Style Signals)

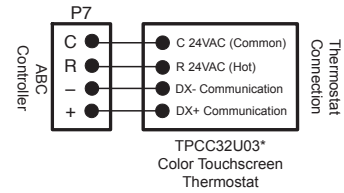

Electrical Information - Flow Centers

Fixed Speed Flow Center

The pump(s) will be connected to the terminals on PB1 in the unit electrical box as shown in Figure 15. The pumps will automatically be cycled as required by the unit or by a signal from another unit sharing the flow center (See Figures 5 and 6). Pumps are protected by circuit breakers (CB) shown in Figure 15.

Figure 15: Single/Dual Cap Unit Wiring for Loop Pumps

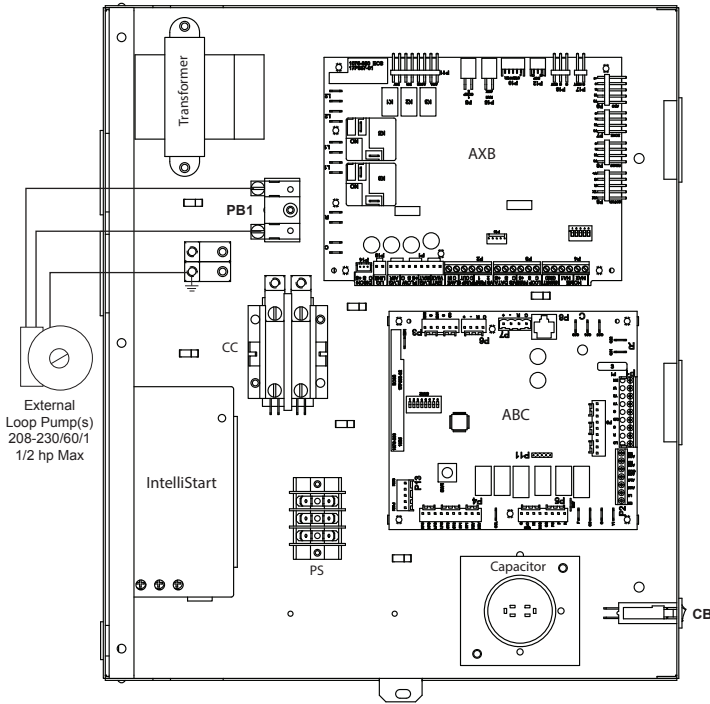

NOTES: For closed loop systems with antifreeze protection, set SW2 DIP Switch #1 to the "Loop" position on units with the Aurora control and SW2-2 should be set to "Loop" on the Premier control.

Figure 16: FCM and FCL Flow Center Wiring (Not Referenced)

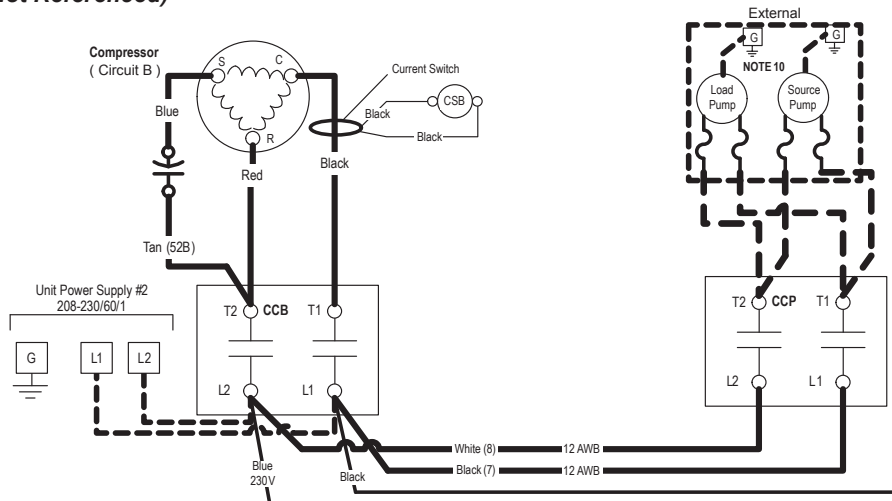

NOTES: FCM and FCL Flow Centers must be wired to a separate contactor (20 amp minimum). The HydroZone Accessory Control Box works best for this application.

For additional information on Flow Center installation, please reference Flow Center installation manual

Closed Loop Ground Source Systems

NOTE: For closed loop systems with antifreeze protection, set SW2-1 to the "LOOP" (15°F) position. (Refer to the DIP Switch Settings table in the Aurora Control section.)

Once piping is completed between the unit, pumps and the ground loop (see figure below), final purging and charging of the loop is required. A flush cart (or a 1.5 HP pump minimum) is needed to achieve adequate flow velocity in the loop to purge air and dirt particles from the loop itself. Antifreeze solution is used in most areas to prevent freezing. Flush the system adequately to remove as much air as possible then pressurize the loop to a static pressure of 40-50 psi (summer) or 50-75 psi (winter). This is normally adequate for good system operation. Loop static pressure will fluctuate with the seasons. Pressures will be higher in the winter months than during the cooling season. This fluctuation is normal and should be considered when initially charging the system.

After pressurization, be sure to turn the venting (burping) screw in the center of the pump two (2) turns open (water will drip out), wait until all air is purged from the pump, then tighten the plug. Ensure that the loop pumps provide adequate flow through the unit(s) by checking the pressure drop across the heat exchanger and comparing it to the unit capacity data in this catalog. 2.5 to 3 gpm of flow per ton of cooling capacity is recommended in earth loop applications.

Figure 7: Closed Loop Ground Source Application

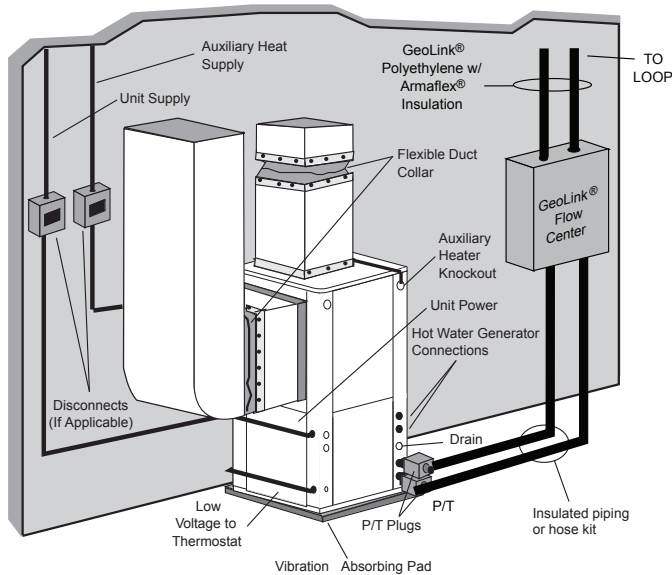

NOTE: Additional information can be found in Flow Center installation manual and Flush Cart manual.

Multiple Units on One Flow Center

NOTE: This feature is only available in the Aurora Advanced Control package (AXB board), NOT the Aurora Base Control (ABC).

When two units are connected to one loop pumping system, pump control is automatically achieved by connecting the SL terminals on connector P2 in both units with 2-wire thermostat wire. These terminals are polarity dependant (see Figure 8b). The loop pump(s) may be powered from either unit, whichever is more convenient. If either unit calls, the loop pump(s) will automatically start. The use of two units on one flow center is generally limited to a total of 20 gpm capacity. It is recommended that water solenoid valves be installed on heat pumps that share a flow center. This is to allow water flow through only the heat pump that has a demand. Circulating fluid through a heat exchanger of a system that is not operating could be detrimental to the long term reliability of the compressor.

NOTE: To achieve this same feature when heat pumps have only the Aurora Base Control, follow Figure 8a. Installer will be required to supply fuses, two relays, and wiring.

Figure 8a: Primary/Secondary Wiring with Aurora Base Control (no AXB Board)

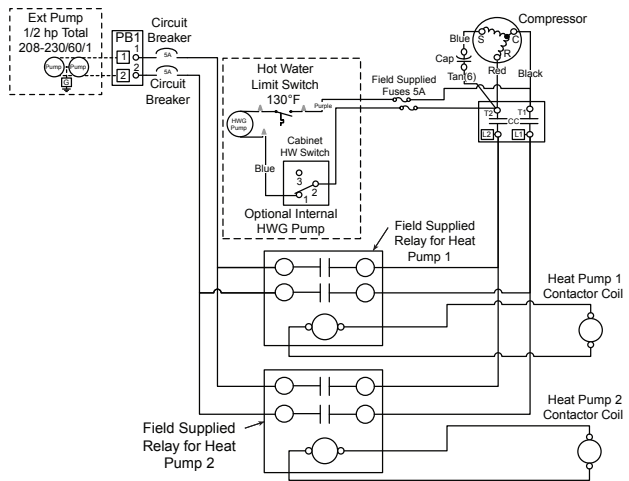
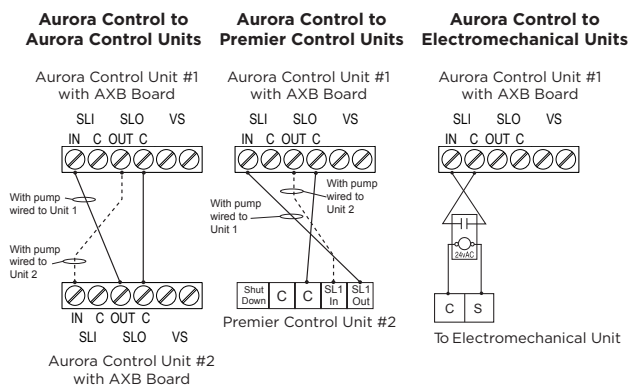

Figure 8b: Primary/Secondary Hook-up



Open Loop Ground Water Systems

Variable Speed Pump Setup

When using a variable speed pump flow center (FCV1-GL or FCV2-GL) the use of an AID Tool will be necessary to adjust minimum and maximum flow rates. The factory default is: minimum=75% and maximum=100% speed levels. Typical open loop piping is shown below. Always maintain water pressure in the heat exchanger by placing water control valves at the outlet of the unit to prevent mineral precipitation. Use a closed, bladder-type expansion tank to minimize mineral formation due to air exposure. Ensure proper water flow through the unit by checking pressure drop across the heat exchanger and comparing it to the figures in unit capacity data tables in the specification catalog. 1.5-2 gpm of flow per ton of cooling capacity is recommended in open loop applications.

Discharge water from the unit is not contaminated in any manner and can be disposed of in various ways, depending on local codes, i.e. recharge well, storm sewer, drain field, adjacent stream or pond, etc. Most local codes forbid the use of sanitary sewer for disposal. Consult your local building and zoning departments to assure compliance in your area.

NOTE: For open loop/groundwater systems or systems that do not contain an antifreeze solution, set SW2-Switch #1 to the "WELL" (30°F) position. (Refer to the DIP Switch Settings table in the Aurora Control section.) Slow opening/closing solenoid valves (type V100FPT) are recommended to eliminate water hammer.

Figure 9a: Open Loop Solenoid Valve Connection Option
 Typical quick operating external 24V water solenoid valve (type PPV100 or BPV100) wiring.

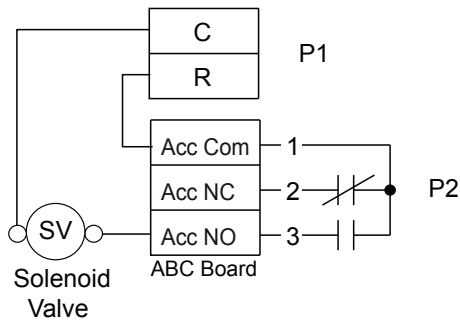

NOTE: SW2-4 and SW2-5 should be "OFF" to cycle with the compressor.

Figure 9b: Open Loop Solenoid Valve Connection Option
 Typical slow operating external 24V water solenoid valve (type V100FPT) wiring.

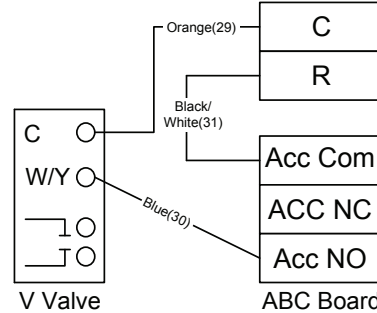

NOTE: SW2-4 should be "ON" and SW2-5 should be "OFF" when using a slow opening (V100FPT) water valve.

Figure 9c: Modulating Water Valve Connection Option
 Typical 0-10VDC modulating water valve.

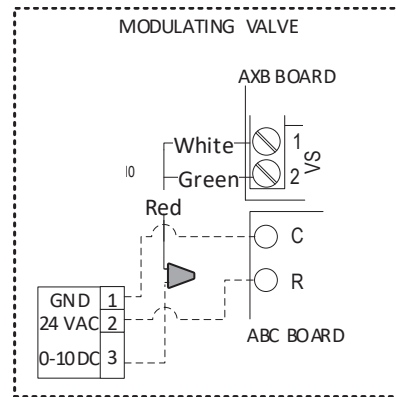
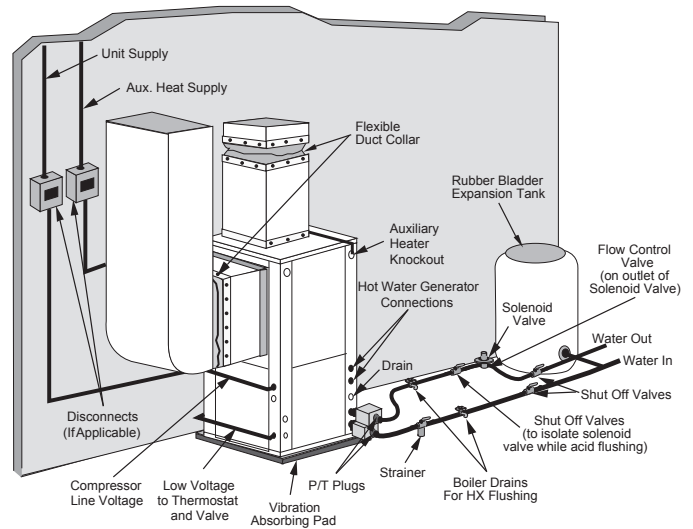

Figure 10: Open System - Groundwater Application



Compressor & Thermistor Resistance

Thermistor Temperature (°F)	Microprocessor Resistance (Ohms)
5	75757-70117
14	57392-53234
23	43865-40771
32	33809-31487
41	26269-24513
50	20570-19230
59	16226-15196
68	12889-12093
77	10310-9688
86	8300-7812
95	6723-6337
104	5480-5172
113	4490-4246
122	3700-3504
131	3067-2907
140	2554-2424
149	2149-2019

Heat Pump Model	Compressor Model No.	208-230/60/1	
		Run	Start
036	YAS30K1E-PFV	0.67 - 0.78	1.37 - 1.57
048	YAS40K1E-PFV	0.41 - 0.47	1.54 - 1.78
060	YAS51K1E-PFV	0.35 - 0.41	1.34 - 1.55
072	YAS60K1E-PFV	0.31 - 0.35	1.30 - 1.50

11/14/23

Reference Calculations

Heating Calculations:	Cooling Calculations:
$LWT = EWT - \frac{HE}{gpm \times 500}$	$LWT = EWT + \frac{HR}{gpm \times 500}$
$LAT = EAT + \frac{HC}{cfm \times 1.08}$	$LAT (DB) = EAT (DB) - \frac{SC}{cfm \times 1.08}$
$TH = HC + HW$	$LC = TC - SC$
	$S/T = \frac{SC}{TC}$

Legend

Abbreviations and Definitions

HWR = Hot Water Return
 HWS = Hot Water Supply
 CWR = Cold Water Return
 CWS = Cold Water Supply
 HVR = Heat Recovery Return
 HVS = Heat Recovery Supply
 HVP = High Voltage Panel
 LVP = Low Voltage Panel
 TC = Total Cooling Capacity in MBTUH
 MBTUH = Thousands of British Thermal Units per hour
 LWT = Leaving Water Temperature

EWT = Entering Water Temperature
 EER = Energy Efficiency Ratio (TC/kW)
 COP = Coefficient of Performance (HC/kW x 3.413)
 PSI = Pressure drop in pounds per square inch
 HC = Heating Capacity in MBTUH
 HE = Heat of Extraction in MBTUH
 kW = kilowatt
 ft hd = pressure drop in feet of head
 HR = Heat of Rejection

Preventative Maintenance

Water Coil Maintenance

1. Keep all air out of the water. An open loop system should be checked to ensure that the well head is not allowing air to infiltrate the water line. Lines should always be airtight.
2. Keep the system under pressure at all times. It is recommended in open loop systems that the water control valve be placed in the discharge line to prevent loss of pressure during off cycles. Closed loop systems must have positive static pressure.

NOTE: On open loop systems, if the installation is in an area with a known high mineral content (125 PPM or greater) in the water, it is best to establish with the owner a periodic maintenance schedule so the coil can be checked regularly. Should periodic coil cleaning be necessary, use standard coil cleaning procedures which are compatible with either the cupronickel or copper water lines. Generally, the more water flowing through the unit the less chance for scaling.

Other Maintenance

Filters

Filters must be clean to obtain maximum performance. They should be inspected monthly under normal operating conditions and be replaced when necessary. Units should never be operated without a filter.

Condensate Drain

In areas where airborne bacteria produce a slime in the drain pan, it may be necessary to treat chemically to minimize the problem. The condensate drain can pick up lint and dirt, especially with dirty filters. Inspect twice a year to avoid the possibility of overflow.

Blower Motors

ECM blower motors are equipped with sealed ball bearings and require no periodic oiling.

Hot Water Generator Coil

See Water Coil Maintenance section above.

Air Coil

The air coil must be cleaned to obtain maximum performance. Check once a year under normal operating conditions and, if dirty, brush or vacuum (with a brush attachment) clean. Care must be taken not to damage the aluminum fins while cleaning.



CAUTION: Fin edges are sharp.

Replacement Procedures

Obtaining Parts

When ordering service or replacement parts, refer to the model number and serial number of the unit as stamped on the serial plate attached to the unit. If replacement parts are required, mention the date of installation of the unit and the date of failure, along with an explanation of the malfunctions and a description of the replacement parts required.

In-Warranty Material Return

Material may not be returned except by permission of authorized warranty personnel. Contact your local distributor for warranty return authorization and assistance.

Troubleshooting

Aurora Control System

NOTE: Refer to the Aurora Base Control Application and Troubleshooting Guide and the Instruction Guide: Aurora Interface and Diagnostics (AID) Tool for additional information.

To check the unit control board for proper operation:

1. Disconnect thermostat wires at the control board.
2. Jumper the desired test input (Y1, Y2, W, O or G) to the R terminal to simulate a thermostat signal.
3. If control functions properly:
 - Check for thermostat and field control wiring (use the diagnostic inputs mode).
4. If control responds improperly:
 - Ensure that component being controlled is functioning (compressor, blower, reversing valve, etc.).
 - Ensure that wiring from control to the component is correct.
 - Refer to the Aurora Base Control Application and Troubleshooting Guide and the Instruction Guide: Aurora Interface and Diagnostics (AID) Tool for additional information.

Refrigerant Systems

To maintain sealed circuit integrity, do not install service gauges unless unit operation appears abnormal. Compare the change in temperature on the air side as well as the water side to the Unit Operating Parameters tables. If the unit's performance is not within the ranges listed, and the airflow and water flow are known to be correct, gauges should then be installed and superheat and subcooling numbers calculated. If superheat and subcooling are outside recommended ranges, an adjustment to the refrigerant charge may be necessary.

NOTE: Refrigerant tests must be made with hot water generator turned "OFF". Verify that air and water flow rates are at proper levels before servicing the refrigerant circuit.

Troubleshooting Checklist

Equipment will not start or operate

- Follow the troubleshooting flow charts to find root cause.

High pressure lockout in the heating mode

- Check for air flow interruption from one or more of the following: inoperative blower, dirty filters or air coil, blocked return air grill, closed or blocked supply registers, restricted supply or return duct, zone dampers, etc. If airflow is suspected as being a problem, make a quick check using the following example: Velocity in a supply duct should not exceed 1000 fpm and 700 fpm in return ducts. For this example we will use an model 038 which has a maximum rating of 1500 cfm at 0.50 static (Refer to the blower performance tables in the install manual for your particular piece of equipment). Using the formula: Area in square feet equals quantity in cfm divided by velocity in fpm ($A = \text{cfm} / \text{fpm}$), 1.57 sq. ft. is needed for the supply duct and 2.14 sq. ft. is needed for the return duct. Refer to the troubleshooting flow charts if a problem with the blower motor or logic board is suspected.
- Check for blocked or seized expansion valve assembly.
- Make sure the discharge pressure is within the operating range shown in the product install manual.
- The unit may be overcharged; check superheat and sub cooling. If this problem is verified, recharge using approved methods.

High pressure lockout in the cooling mode

- Water flow may be restricted or inadequate. Verify in accordance with the pressure drop tables shown in product install manual. Also, look for the following: solenoid valve may not be opening on well water units, pump(s) may be inoperative in the flow center, debris may be blocking coil (back flush using at least 20 PSI), or air may be in the loop (flush loop).
- Water to refrigerant heat exchanger may be fouled with debris. If so, back flush with at least 20 psi of water pressure.
- If mineral accumulation is evident, clean the heat exchanger with acid.
- Entering air temperature may be too high. Equipment is designed for a maximum of 85°F DB and 71°F WB.
- Check for a seized or blocked expansion valve assembly.
- The unit may be overcharged; check superheat and sub cooling. If this problem is verified, recharge using approved methods.

Low pressure lockout in heating mode

- If equipment is installed in a low temperature area (below 50°F), install a crankcase heater, then protect the unit from the elements.
- Water flow may be restricted or inadequate. Verify in accordance with the pressure drop tables shown in product install manual. Also, look for the following: solenoid valve may not be opening on well water units, pump(s) may be inoperative in the flow center, debris may be blocking coil (back flush using at least 20 PSI), or air may be in the loop (flush loop).
- Check for a seized or blocked expansion valve assembly.

- Return air temperature may be below 50°F. Block off air coil temporarily to improve flow of refrigerant through the system. Air below 50°F cannot be tolerated on a continuing basis. Correct the problem.
- Refrigerant may be low. Check for leaks, reclaim refrigerant, repair if necessary, recharge using approved methods.

Low pressure lockout in the cooling mode

- Check for inadequate air flow. Follow the same procedure as shown for a high pressure lockout in the heating mode.
- Check for a seized or blocked expansion valve assembly.
- Refrigerant charge may be low.

Water flow lockout in either the heating or cooling mode

- Water flow may be restricted or inadequate. Verify in accordance with the pressure drop tables shown in product install manual. Also, look for the following: solenoid valve may not be opening on well water units, pump(s) may be inoperative in the flow center, debris may be blocking coil (back flush using at least 20 PSI), or air may be in the loop (flush loop).
- Disconnect freeze sensor from control and measure the resistance. Cross reference with the Thermistor Data table.

Condensate over flow lockout in either the heating or cooling mode

- Make sure the drain line pitches away from the unit. Install a vertical vent on horizontal drain lines over six feet long. Clean condensate pan and be sure outlet and drain line from the condensate pan is clear.

Reversing valve does not operate

- Disconnect solenoid and check for continuity across coil. Replace coil if continuity is not found.
- If stuck reversing valve is suspected, restrict airflow in heating mode (to build pressure), then switch immediately to the cooling mode.

Aurora Interface Diagnostic (AID) Tool

Aurora Input-Output Diagnostics



Troubleshooting the Aurora logic board can be accomplished using nothing more than a couple of jumper wires and a volt meter. The process can be simplified with the use of the Aurora Interface Diagnostic Tool (AID Tool). The AID Tool allows the user to see lockout and fault history information, thermostat inputs, sensor inputs, system outputs, timer, etc.

Aurora ABC Checkout

Before replacing the Aurora ABC control board the proper troubleshooting steps must be taken to ensure that the board is the root cause. On the following pages are several flow charts that will assist in checking the control board. If it is found that the control board is faulty, contact technical services for a replacement part.

Blower Speed Selection Number	PWM %	Dehumidification PWM %
1	2	2
2	11	3
3	19	9
4	31	20
5	41	28
6	52	37
7	60	44
8	68	51
9	78	59
10	89	69
11	95	74
12	98	76

LED Displays

Slow Flash = 1 second on and 1 second off

Fast Flash = 100 ms on and 100 ms off

Flash Code = 100 ms on and 400 ms off with a 2 second pause between packages

SW1 Operation

Holding SW1	Description of Operation	LED
2 to 5 sec	Enter Test Mode	Green LED Slow Flash
5 to 10 sec	Enter ECM Configure Mode	Yellow LED Off
50 to 60 sec	Reset Configure Mode (default)	Yellow LED Off
> 60 sec	SW1 Operation Cancel	Yellow LED Back to Normal

“SW1 operation cancel,” holding SW1 for longer than 60 seconds operation will be cancelled. Yellow LED will go back to normal operation.

Fault Retries Before Lockout

Type of Fault	Total Tries Before Lockout
High Pressure	3 Retries
Low Pressure	3 Retries
Freeze Detection 1 - (Coax)	3 Retries
Freeze Detection 2 - (Air coil)	3 Retries
Condensate Overflow	3 Retries
Over/Under Voltage Shutdown	No Lockout
Compressor Monitor	No Retry
Freeze Detection Sensor Error (Sensor is out of range)	No Retry

Preliminary Checkout Procedure

Troubleshooting liquid source heat pumps with Aurora controls is an easy and straight forward process. Most service problems are related to water flow (insufficient or too cold). Also, most service problems can be fixed without connecting refrigerant manifold gauges.

The first item to check is system performance which can be done in six steps. Before beginning make sure the hot water generator pump is disconnected.

STEP 1: Check and/or set source water flow. Refer to the install manual for the specific piece of equipment’s correct water flow setting.

STEP 2: Check the temperature difference through the coaxial heat exchanger and compare to the Operating Parameters table in the equipment install manual.

STEP 3: Check the air temperature rise/drop and compare to the Operating Parameters table in the equipment’s installation manual.

STEP 4: If the first three steps check out, perform a heat of extraction/rejection test as described in the Water Side Analysis: Heat of Extraction/Rejection section to confirm proper operation.

STEP 5: If any or all of the above steps do not check out, be sure that the air coil and filter are clean.

STEP 6: Check superheat and subcooling by placing refrigeration gauges on the unit. Compare superheat and subcooling values with the charts in the equipment installation manual.

If the above six steps do check out, it would be safe to assume that the unit is performing well and the problem must lie elsewhere, i.e. excessive heat loss/gain in the structure or duct system, (undersized duct and/or registers, etc.)

If you suspect a specific problem, refer to the Table of Contents and select the reference that most closely matches the situation encountered. If problems persist after completing the preliminary checkout procedure, refer to the Troubleshooting Checklist. Select the problem which is closest to the situation you have encountered.

Control Board Troubleshooting Steps

1) General Check

- If any new device was installed, or any wiring was changed, check the connections to ensure the wiring is correct, and all the wires are in good condition.
- Verify all the plugs are securely connected and in good condition.
- Check the DIP switch (SW2) positions are correct.
- Measure 24 VAC between R and C. (The actual reading may be from 18 to 30 VAC). Check the incoming power and the power transformer if the R and C voltage reading is not correct.

2) No LEDs are On

- Check 24 VAC on board.
- Check the 3 amp fuse. Replace the fuse if needed.
- Verify transformer circuit breaker has not tripped if no low voltage is present.
- Disconnect the thermostat connection P1.
- Replace the Aurora base control board.

3) Red LED Flash Code

Input Fault (Code 1) – Indicates that both O and W input signals are present. Disconnect the thermostat connector from the ABC board and then cycle power to the board. If the fault does not reappear, then the problem is between the thermostat and the thermostat connector. Otherwise, replace the ABC board.

High Pressure Fault (Code 2) – Indicates the system pressure has exceeded 600 psi (R-454B) which may have been caused by low water flow in cooling, (check coaxial heat exchanger for mineral build-up) or low air flow in heating (check filters and coil for dirt build-up). Measure P4-9 and C is 24 VAC. If not, replace ABC. Check the heat pump refrigeration system. Cycle the power to reset the system. Measure P4-10 and C is 24 VAC. If not, replace the high pressure sensor.

Low Pressure Fault (Code 3) – Indicates low pressure switch has opened which may indicate a loss of system charge, system restriction, or frozen heat exchanger. Measure P4-7 and C is 24 VAC. If not, replace ABC. Check the heat pump refrigeration system. Cycle the power to reset the system. Measure P4-8 and C is 24 VAC. If not, replace the low pressure sensor. Refrigerant may be low. Check for leaks, reclaim refrigerant, repair if necessary, pump down and recharge the system to the quantity of refrigerant shown on the unit nameplate.

Freeze Detection 1 Fault (Code 5) – Indicates low or no water flow; low system charge; or faulty TXV in heating mode. Make sure the DIP switch FP1 (SW2-1) selection matches the application. Measure the temperature on the refrigerant line next to the freeze detection thermistor. Disconnect the connector P4. Measure the resistance reading between P4-3, P4-4. Refer to the Thermistor Data table, find the corresponding temperature data. Compare the data with the temperature measurement from the refrigerant line. The temperature should be within +/- 2° F. If not, replace the thermistor.

Other items to check when troubleshooting a water flow lockout are superheat, water flow through the coaxial heat exchanger and antifreeze composition. High superheat in heating will lower the refrigerant line temperature where the freeze detection thermistor is located. In this case, check the TXV. Closed loop systems are rated at 3 gpm/ton. If a closed loop system is running at less than 3 gpm/ton, the temperature difference between the refrigerant line and the actual leaving water temperature will be greater and could lead to possible water flow lockouts.

Condensate Fault (Code 7) – Indicates condensate water in the drain pan fills up and touches the spade terminal. Make sure the drain line pitches away from the unit. Install a vertical vent on horizontal drain lines over six feet long. Clean and be sure outlet and drain line from the condensate pan is clear. Jumper between R, Y2 and O to start 2nd stage cooling. Observe the water level in the drain pan. If the unit is locking out on condensate and the drain pan is dry, remove the condensate wire from the drain pan and tape it out of the way. Be careful to not ground the wire out because that will cause the unit to lockout on drain overflow. If the unit is still locking out, check the brown wire all the way back to the ABC for a short to ground. Remember that the condensate sensor is just a wire looking for a ground. If it touches any metal in the cabinet, the unit will see that as a drain fault. If removing the wire from the drain pan stopped the false drain lockouts, put the condensate sensor back in place in the drain pan. Pay close attention to how far the spade terminal sits down in the drain pan. If the terminal is pushed all the way down so that it is touching the bottom of the drain pan, this will cause a drain lockout if there is any trace of water. If the spade terminal fits loosely in the drain pan, spread the terminal open to make it fit snugly in the drain pan.

Over/Under Voltage Shutdown Fault (Code 8) – Indicates the control voltage is or had been outside the range of 18 to 30 VAC for more than 15 minutes. Using a voltage meter, check the incoming power line voltage is within + or – 25%. If not, there is a power line issue. Check the secondary of the control transformer with a voltage meter. The voltage should be 18 to 30 VAC. If not, replace the control transformer.

Freeze Detection FP1 Sensor Fault (Code 11) – Indicates the freeze detection sensor is out of range. Disconnect the connector P4. Measure the resistance reading between P4-3, P4-4. Refer to the Thermistor Data table, find the corresponding temperature data. Compare the data with the temperature measurement from the refrigerant line. The temperature should be within +/- 2° F. If not, replace the thermistor.

4) Other Faults

ECM Motor Will Not Start

1. Measure the voltage output between P13-1 and P13-5.
Reference the chart below for blower speed vs. voltage.

Control Board Troubleshooting Steps cont.

Blower Speed Selection Number	DC Volts
1	0.6 VDC
2	2.7 VDC
3	4.6 VDC
4	7.5 VDC
5	9.8 VDC
6	12.5 VDC
7	14.4 VDC
8	16.3 VDC
9	18.5 VDC
10	21.2 VDC
11	22.3 VDC
12	23.4 VDC

- Measure the voltage from C to F terminals (P5-2). The reading should be 24VAC.

Compressor First Stage Will Not Start – Measure the voltage output between P5-4 and P5-5, P5-7 and P5-8. The reading should be 24 VAC. If 24 VAC is not present check transformer output, thermostat wiring, current fault status, etc.

Compressor Second Stage Will Not Start – Measure the voltage output between P5-6 and P5-8. The reading should be 24 VAC. If 24 VAC is not present, check DIP switch settings, thermostat operation, and thermostat wiring.

No Alarm Output – Measure the voltage output between P2-4 and C. The reading should be 24 VAC or a pulsed 24 VAC dependent on the selection of SW2-7. If SW2-8 is set for reheat, the alarm output will be used to control the hot gas reheat valve and will not show lockout information.

Accessory Relay Does Not Operate – Measure the continuity between P2-2 and P2-3. It should read closed when relay is engaged. If this is not correct, check SW2-4 and SW2-5 settings.

No Lockout Output – Measure the voltage output between P1-1 and C. The reading should be 24 VDC or a pulsed 24 VDC dependent on the selection of SW2-7. If voltage is not present, make sure the unit is in lockout and not fault retry.

Auxiliary Heater Does Not Function – Measure the voltage output between P3-1, P3-2, and P3-3, P3-4. The output should be 24 VDC. If voltage is not present, check thermostat operation and wiring.

Loop Pump Does Not Start – The loop pump is controlled by the AXB board. Check to make sure the control board is powered by taking a voltage reading across R and C to check for 24VAC. If 24VAC is not present check the wiring connections, 24VAC is supplied to the AXB through the harness connected to P9. Next check to make sure the ABC is attempting to run the compressor, the loop pump will only run when the ABC is commanding CC on, the pump slave input is active, or the AXB has lost communication with the ABC. Please refer to troubleshooting flow charts for additional checks on the loop pump.

5) Operation Modes

Enter First Stage Heating – Remove P1. Place a jumper between R and Y1.

Enter Second Stage Heating – Remove P1. Place a jumper between R, Y1 and Y2. This is for SW2-6 set to “OFF” position.

Enter Third Stage Heating – Remove P1. Place a jumper between R, Y1, Y2 and W.

Enter First Stage Cooling – Remove P1. Place a jumper between R, O and Y1.

Enter Second Stage Cooling – Remove P1. Place a jumper between R, O, Y1 and Y2.

Enter Emergency Heating – Remove P1. Place a jumper between R and W.

Enter Blower Only Mode – Remove P1. Place a jumper between R and G.

Enter Reheat Mode – Remove P1. Place a jumper between R and DH. (SW2-8 must be off)

These notes are for SW2-3 set to “ON” position.

Control Board Troubleshooting Flow Charts

Use the following flow charts to aid in troubleshooting the control board.

Compressor Will Not Start Without AID Tool

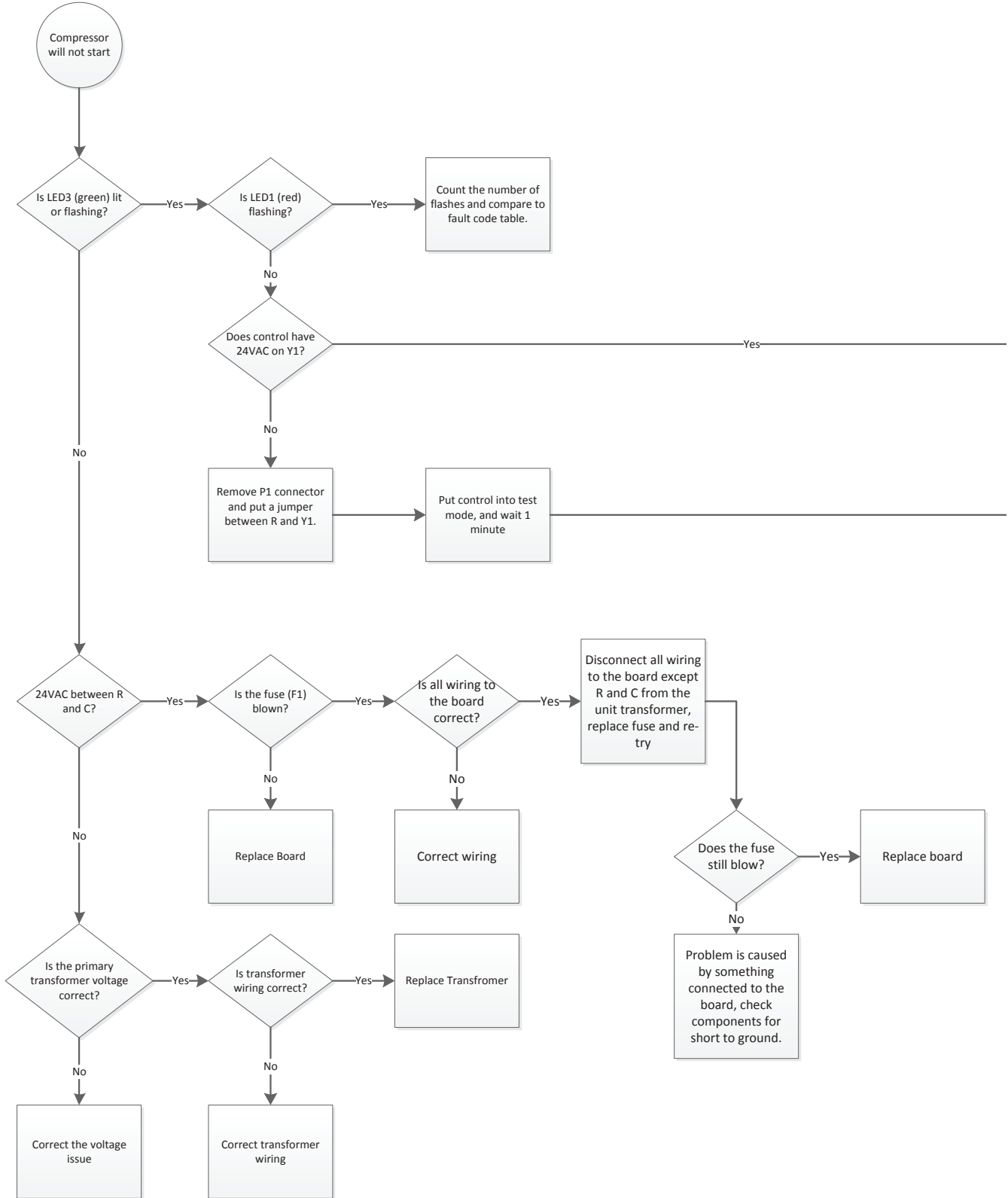

Control Board Troubleshooting Flow Charts cont.

Notes:

1. When measuring 24VAC actual value may be between 18 and 30VAC.

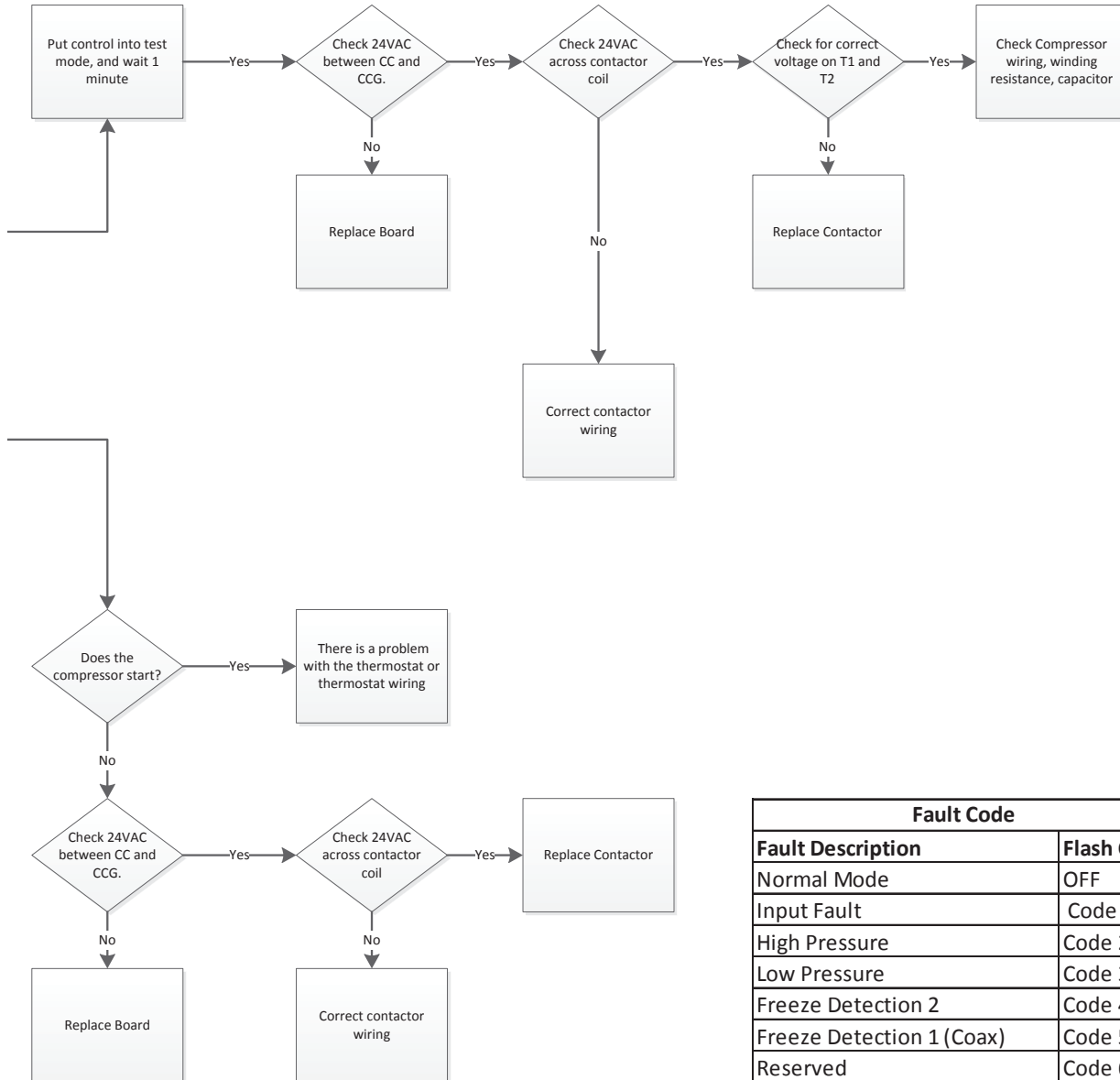

Fault Code	
Fault Description	Flash Code
Normal Mode	OFF
Input Fault	Code 1
High Pressure	Code 2
Low Pressure	Code 3
Freeze Detection 2	Code 4
Freeze Detection 1 (Coax)	Code 5
Reserved	Code 6
Condensate	Code 7
Over/Under Voltage	Code 8
Not Used	Code 9
Freeze Detection Sensor Error	Code 11

NOTE: Refer to the Control Board Troubleshooting Steps for fault descriptions.

Control Board Troubleshooting Flow Charts cont.

Compressor Will Not Start With AID Tool

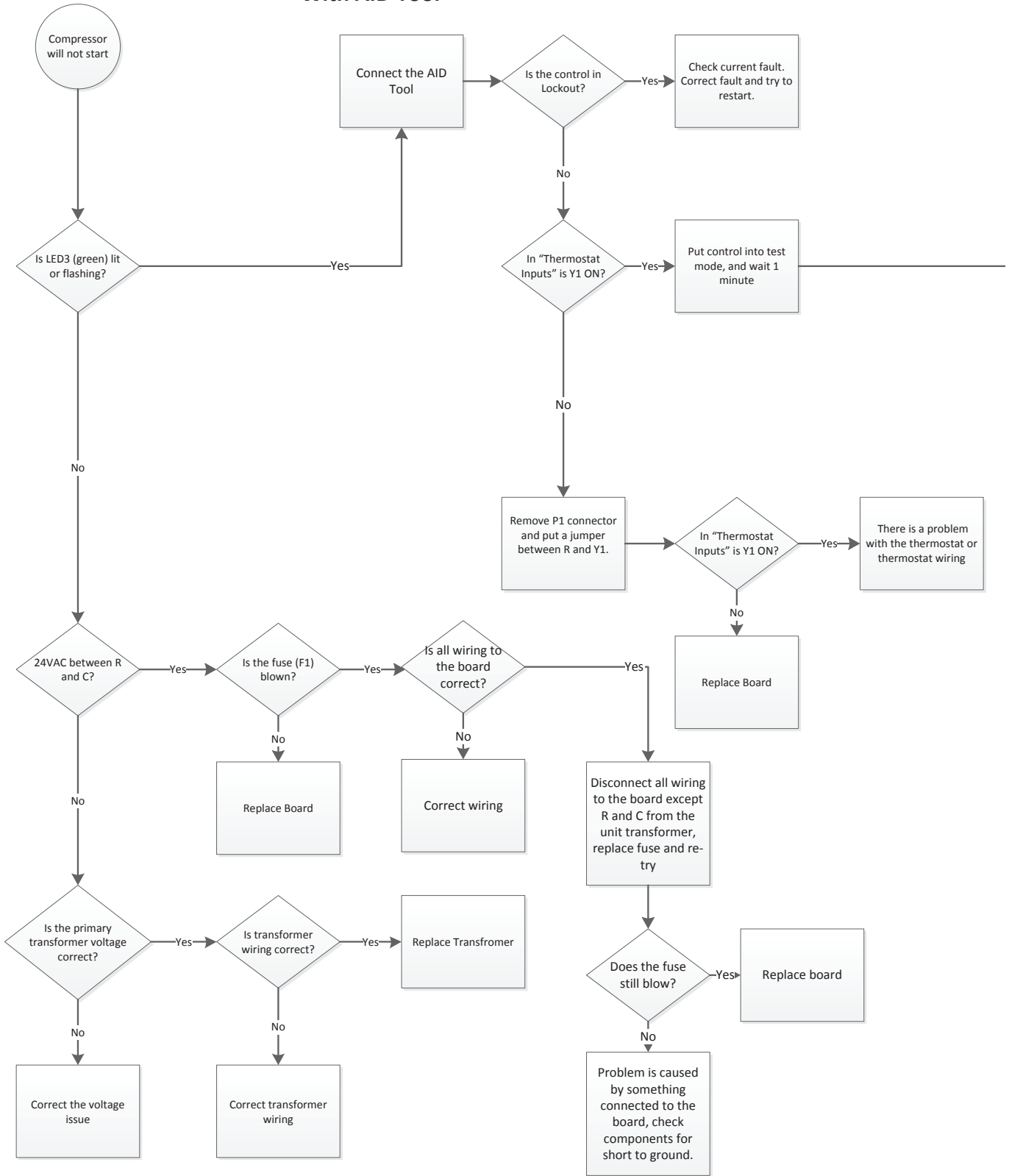

Control Board Troubleshooting Flow Charts cont.

Notes:

1. When measuring 24VAC actual value may be between 18 and 30VAC.

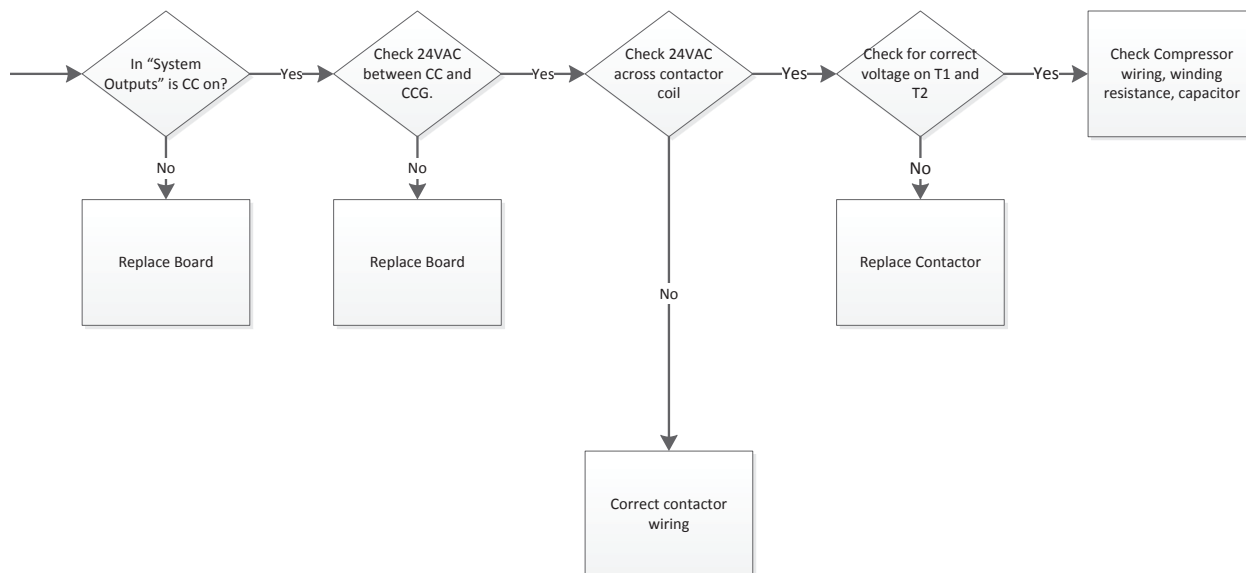

Control Board Troubleshooting Flow Charts cont.

ECM Blower Will Not Start Without AID Tool

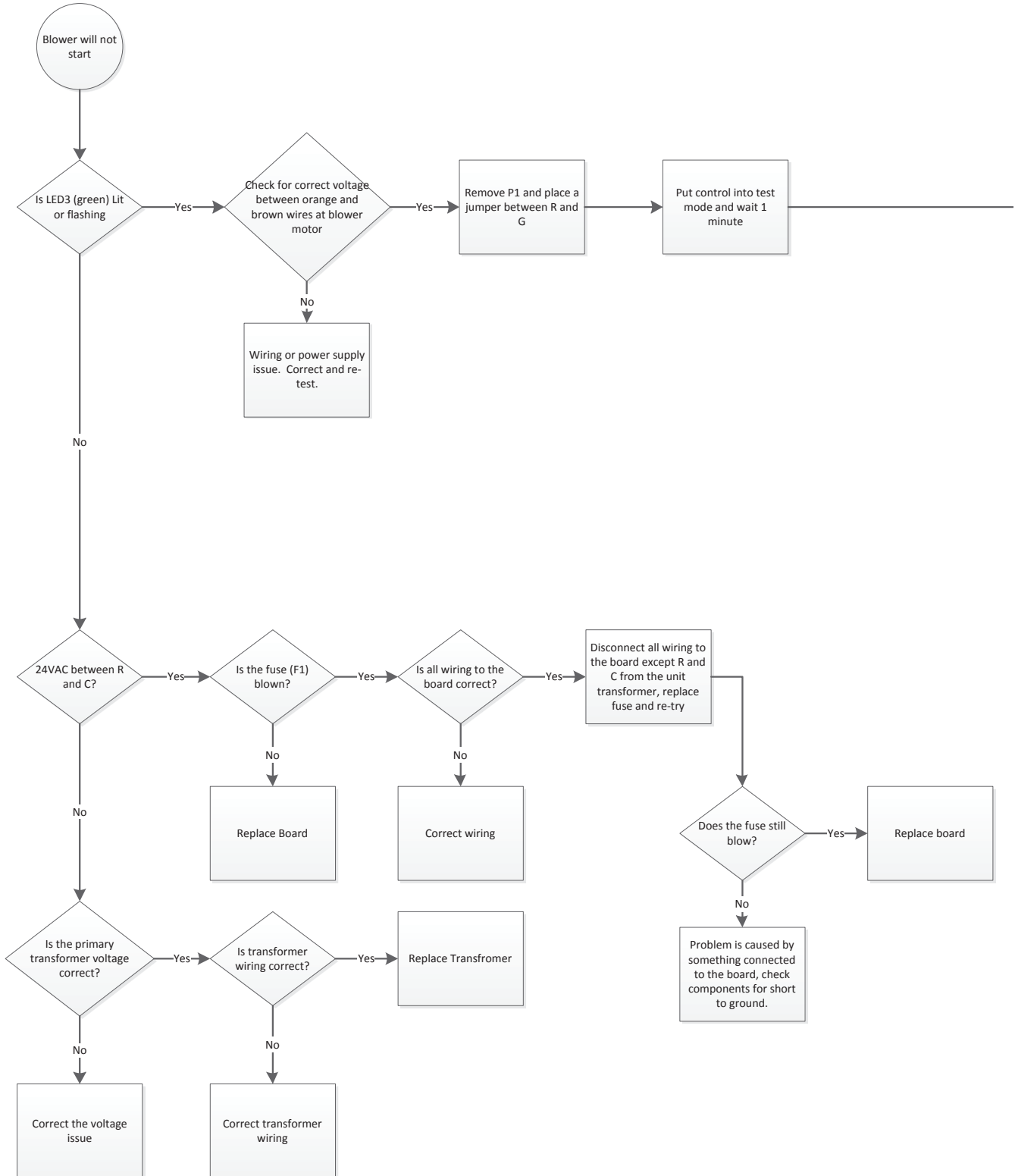

Control Board Troubleshooting Flow Charts cont.

Notes:

1. When measuring 24VAC actual value may be between 18 and 30VAC.

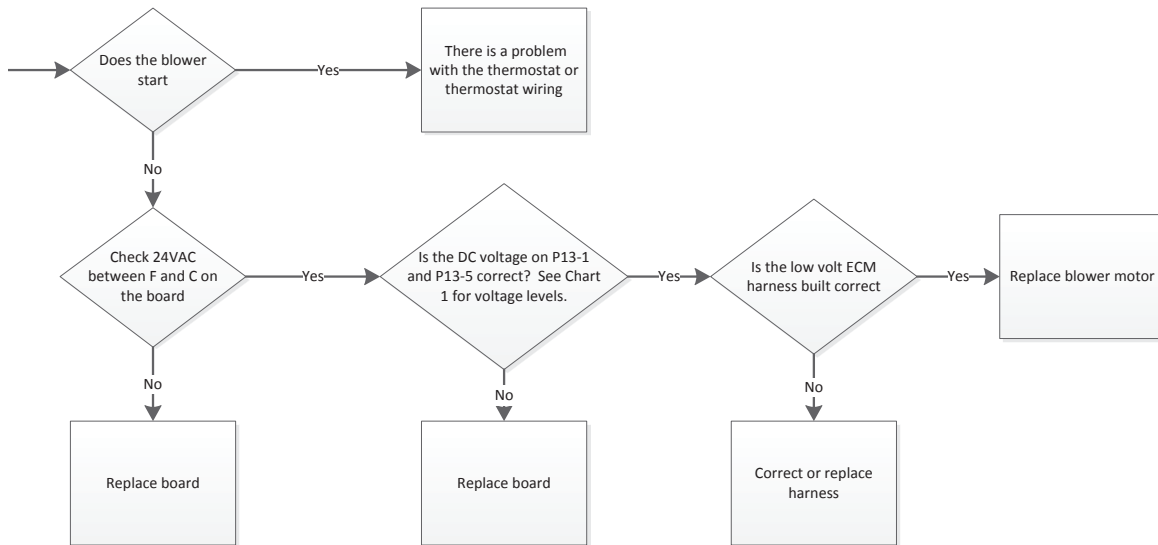
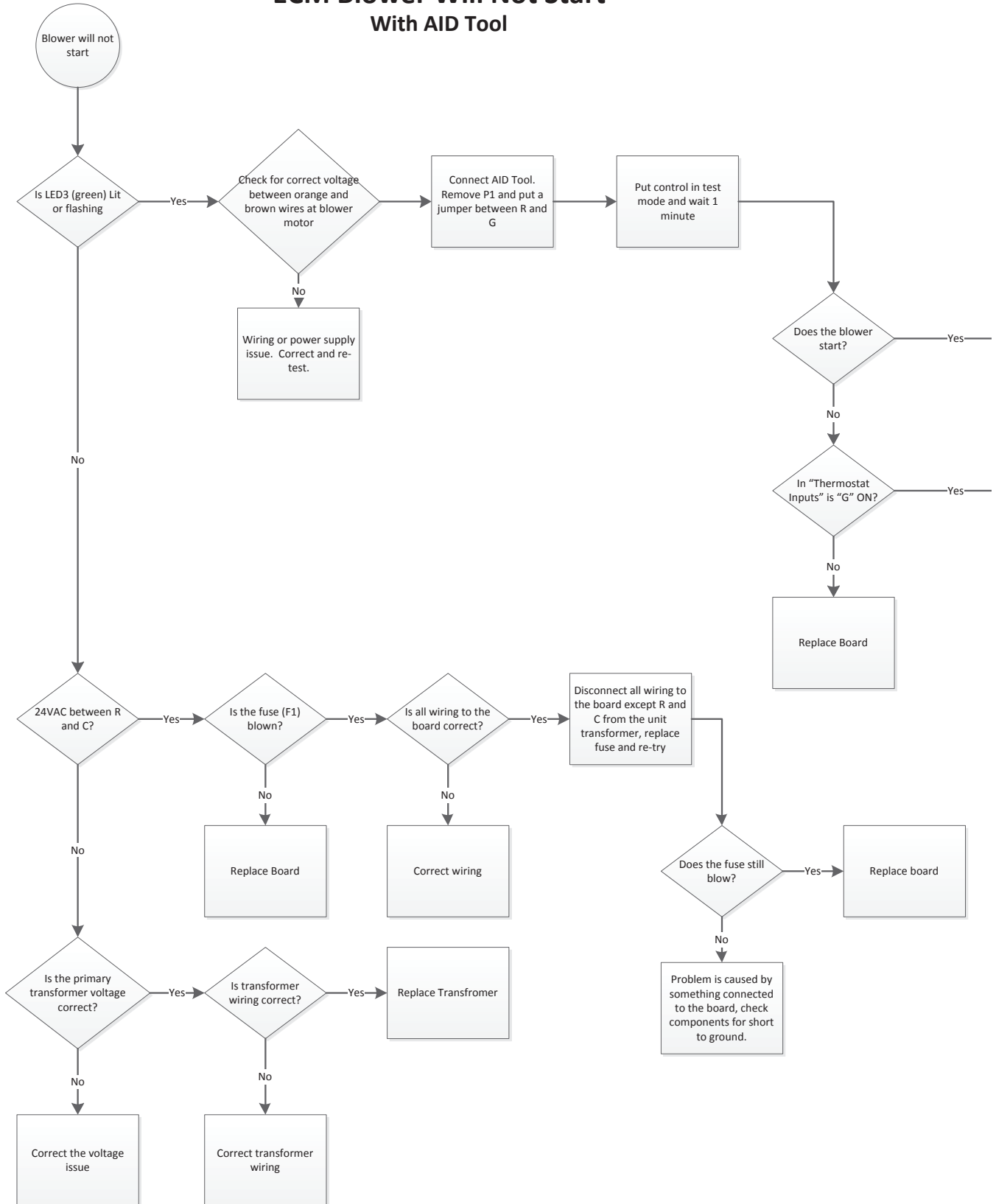

Chart 1

Blower Speed Selection Number	DC Volts
1	0.6VDC
2	2.7VDC
3	4.6VDC
4	7.5VDC
5	9.8VDC
6	12.5VDC
7	14.4VDC
8	16.3VDC
9	18.5VDC
10	21.2VDC
11	22.3VDC
12	23.4VDC

Control Board Troubleshooting Flow Charts cont.

ECM Blower Will Not Start With AID Tool



Control Board Troubleshooting Flow Charts cont.

Notes:

1. When measuring 24VAC actual value may be between 18 and 30VAC.

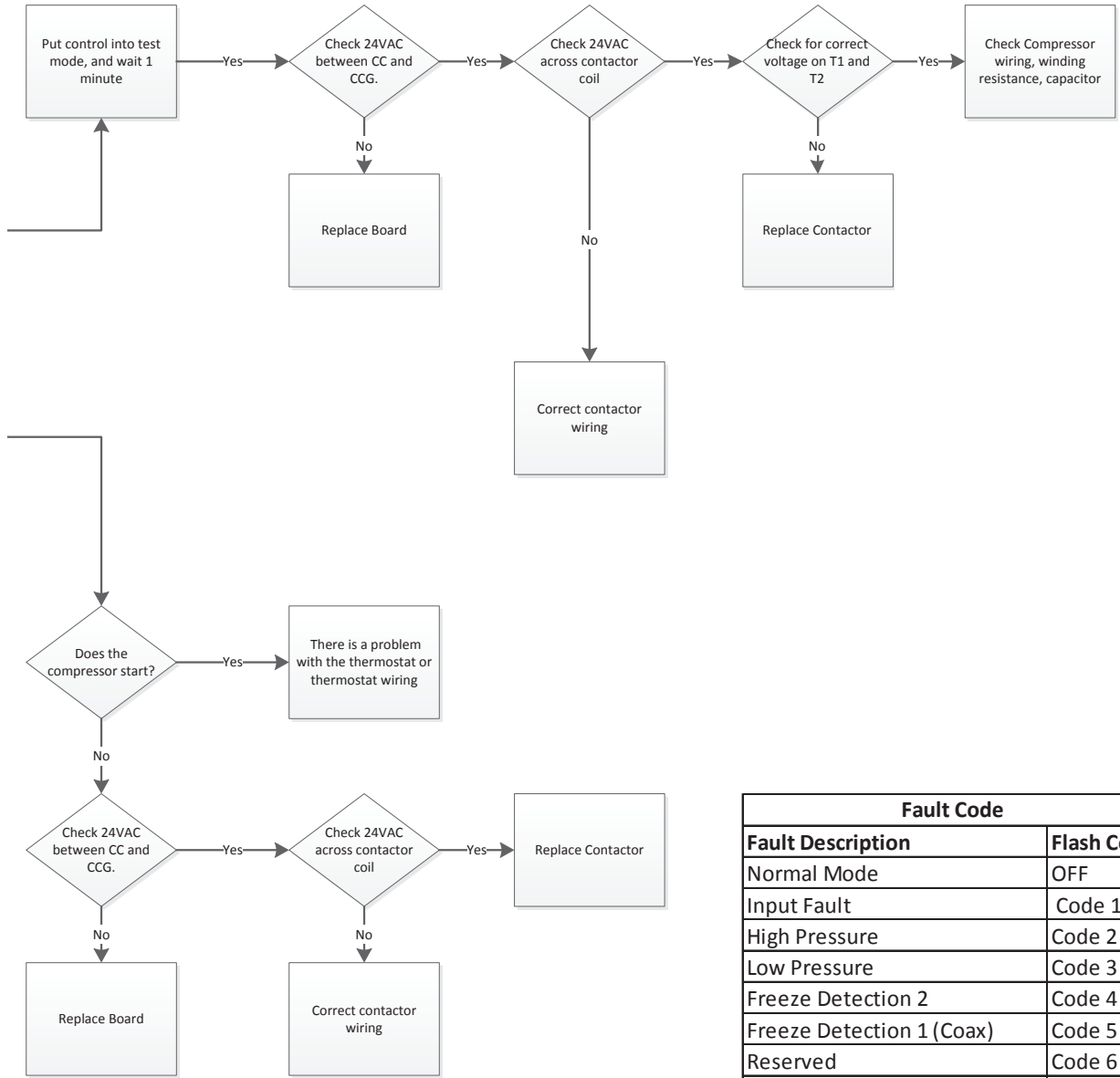

Fault Code	
Fault Description	Flash Code
Normal Mode	OFF
Input Fault	Code 1
High Pressure	Code 2
Low Pressure	Code 3
Freeze Detection 2	Code 4
Freeze Detection 1 (Coax)	Code 5
Reserved	Code 6
Condensate	Code 7
Over/Under Voltage	Code 8
Not Used	Code 9
Freeze Detection Sensor Error	Code 11

Control Board Troubleshooting Flow Charts cont.

Loop Pump Will Not Start Variable Speed Pump

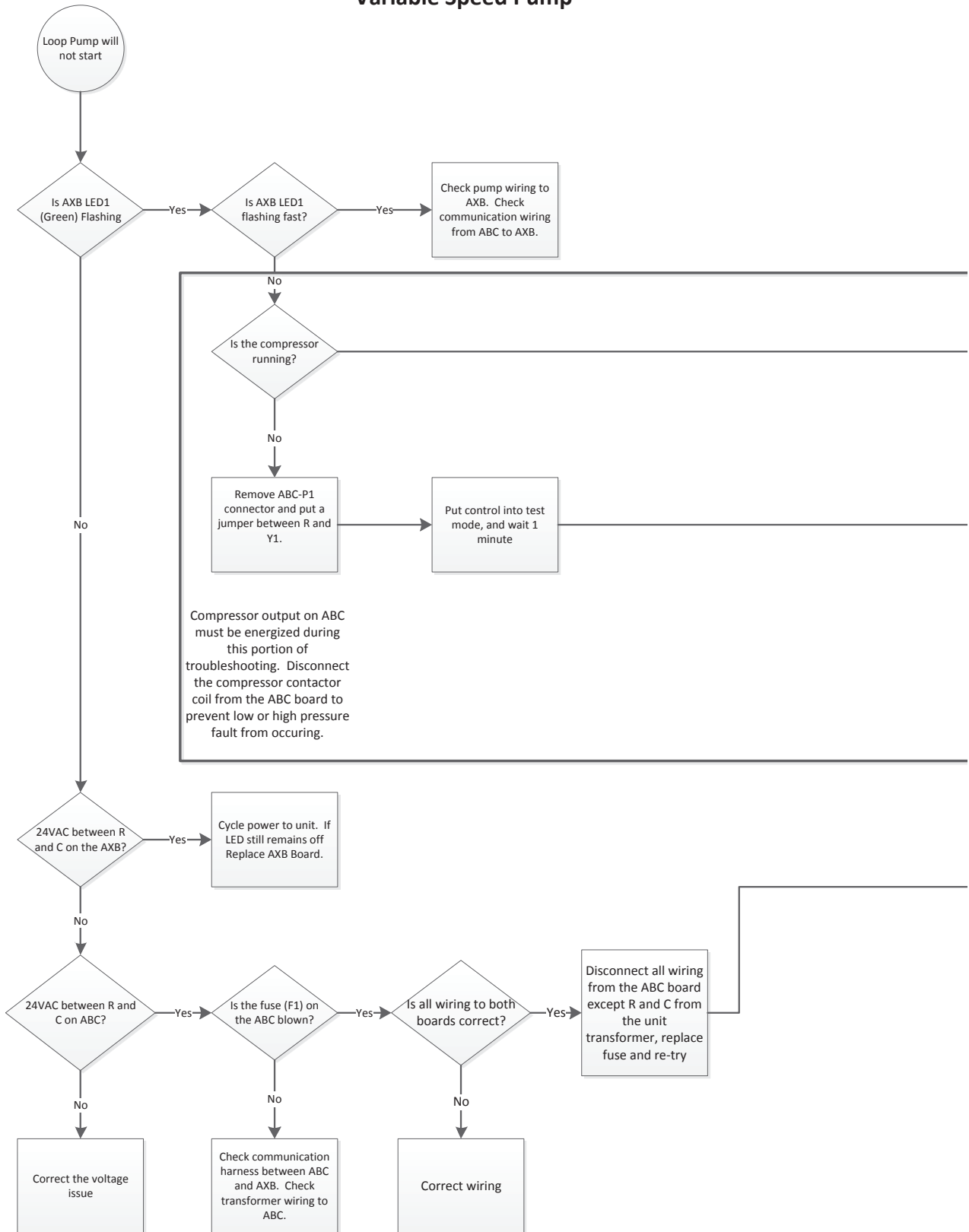

Control Board Troubleshooting Flow Charts cont.

Notes:

1. When measuring 24VAC actual value may be between 18 and 30VAC.
2. When measuring 240VAC actual value may be between 190 and 250 VAC.

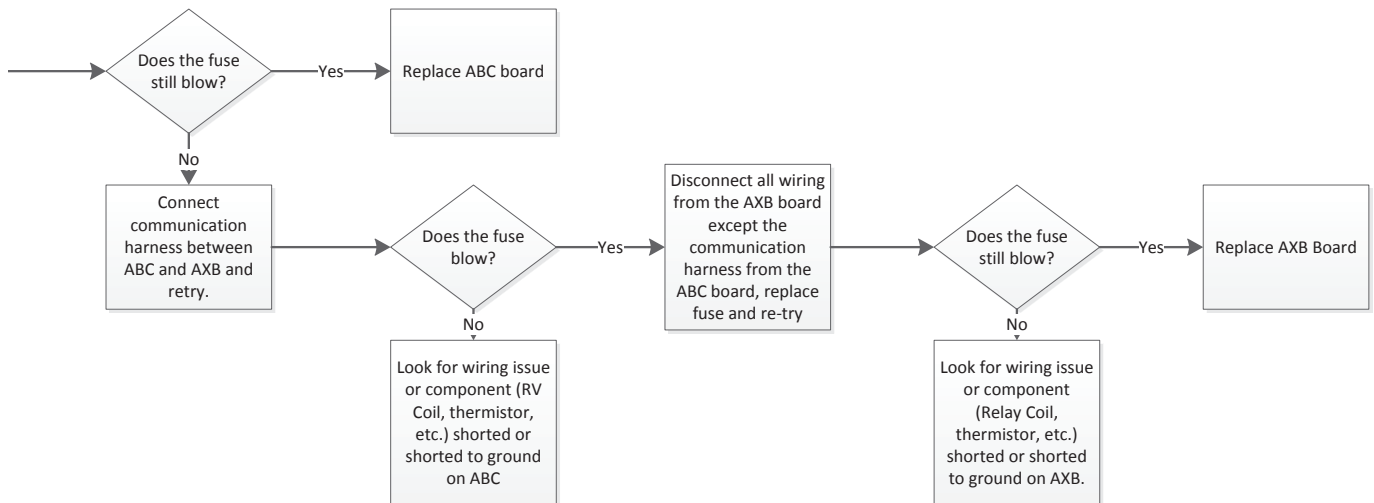
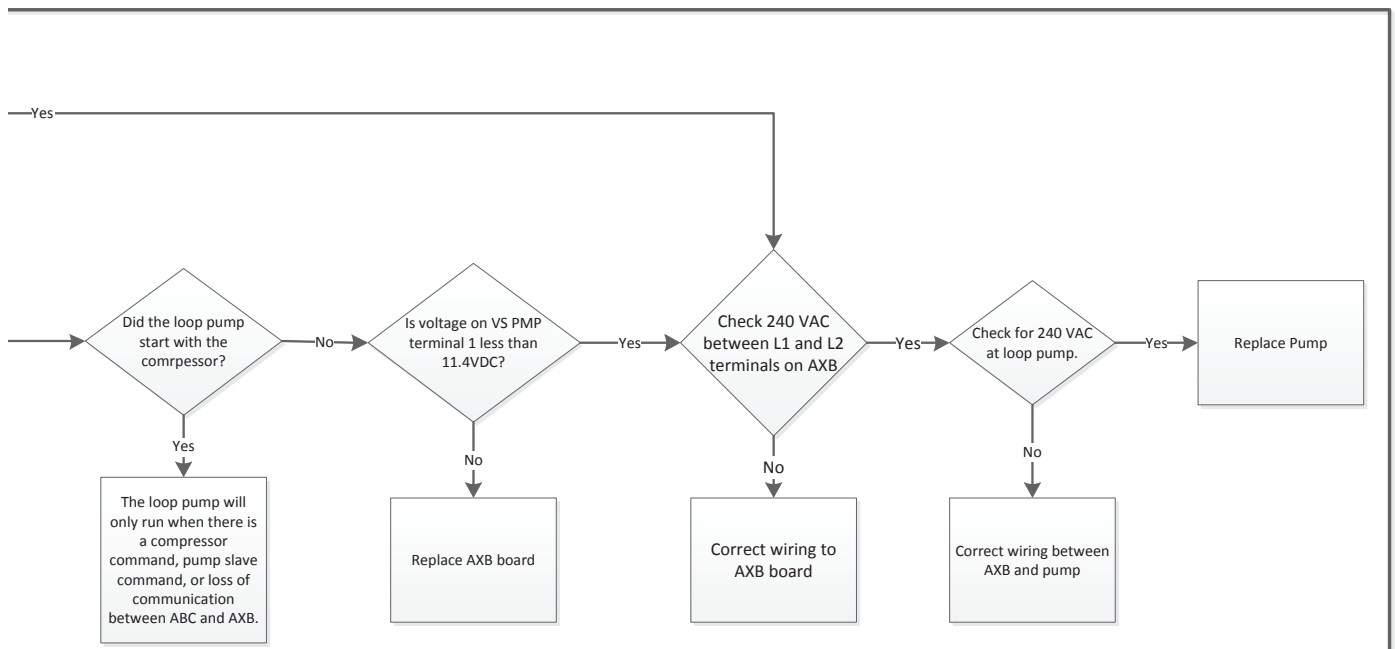

Control Board Troubleshooting Flow Charts cont.

Loop Pump Will Not Start Non Variable Speed Pump

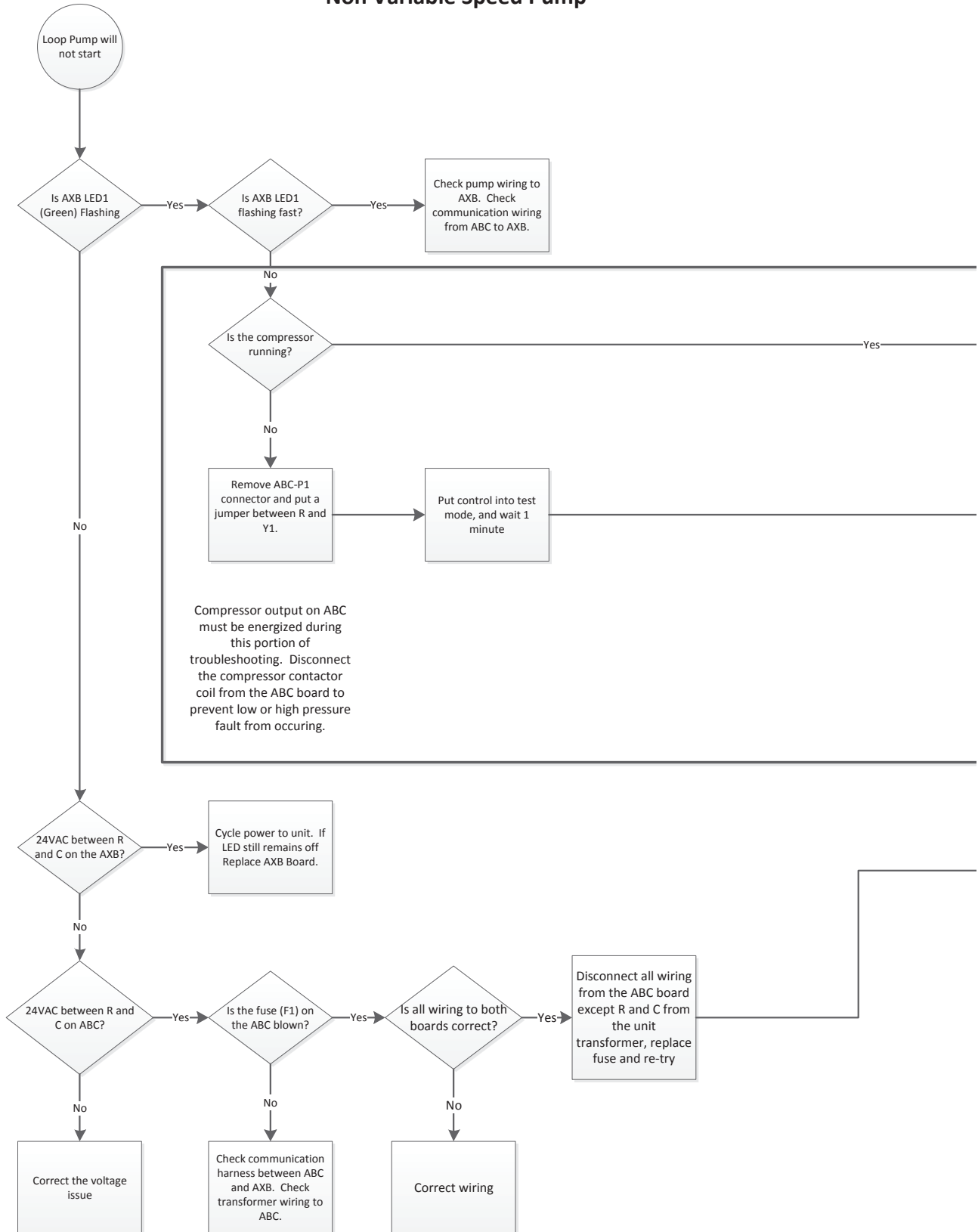

Control Board Troubleshooting Flow Charts cont.

Notes:

1. When measuring 24VAC actual value may be between 18 and 30VAC.
2. When measuring 240VAC actual value may be between 190 and 250 VAC.

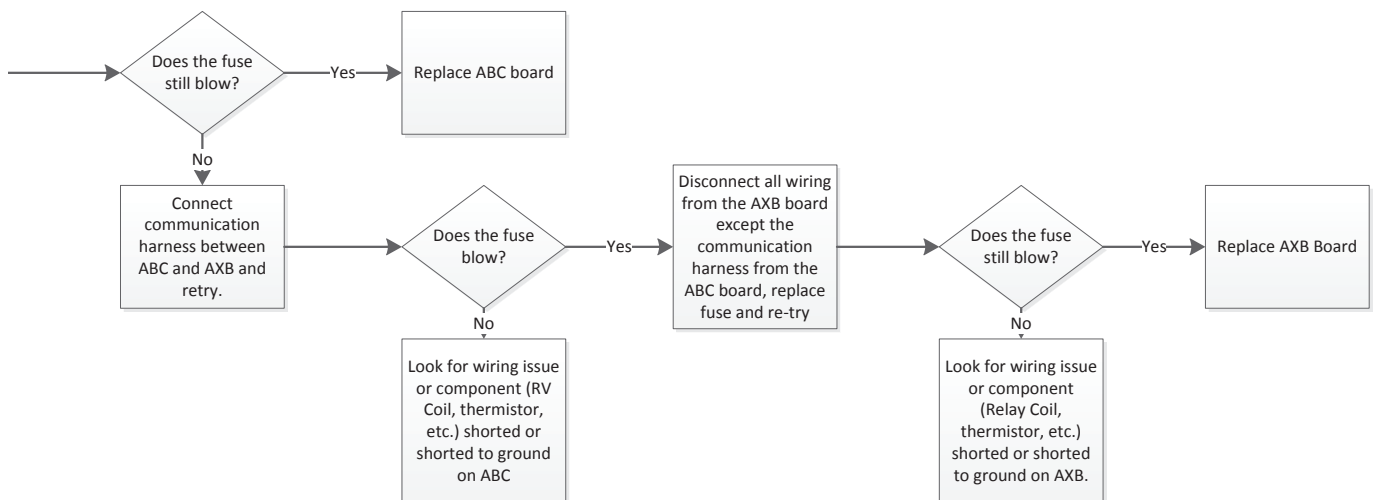
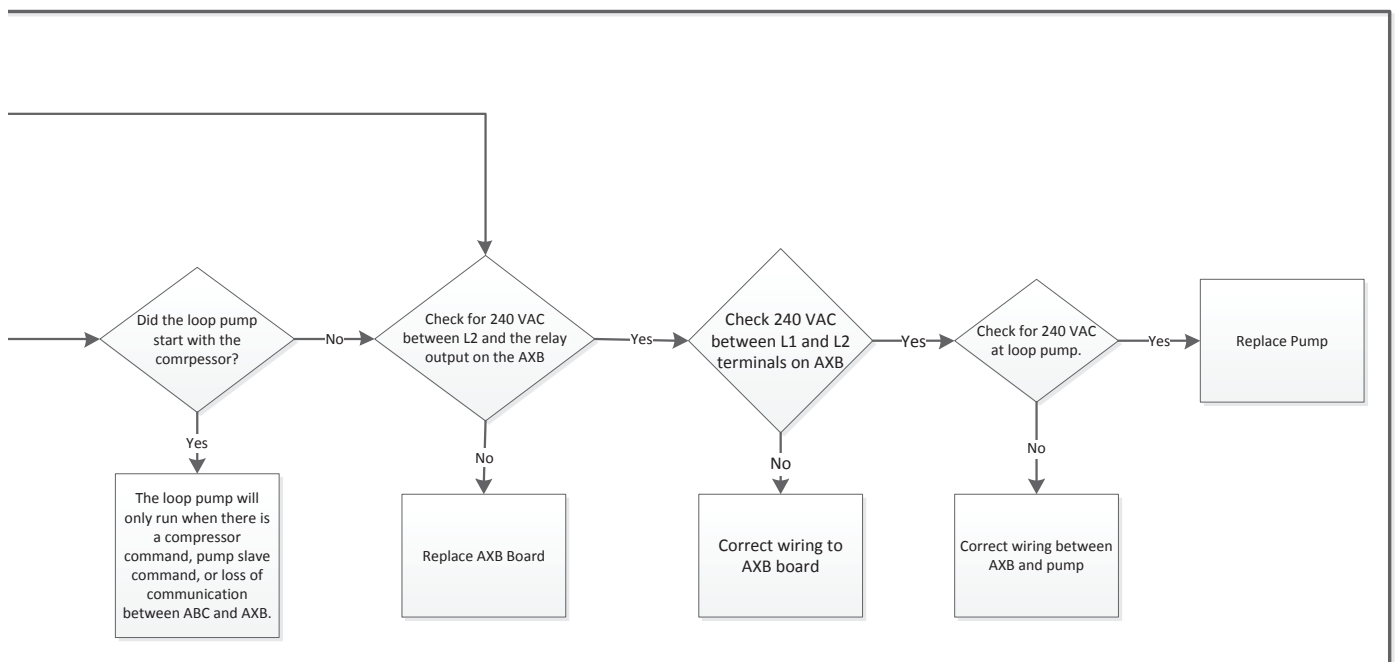

Communicating Thermostat Troubleshooting Guide

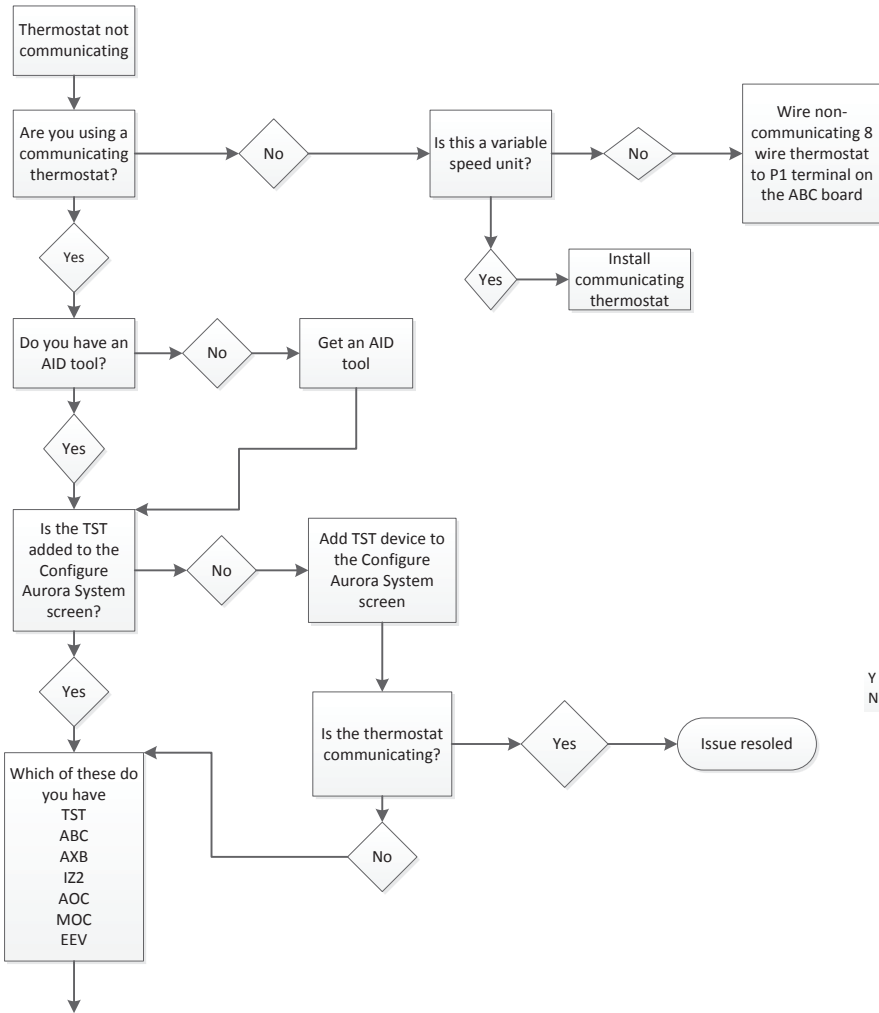

Continue to Next Page

Configure Aurora System Screen

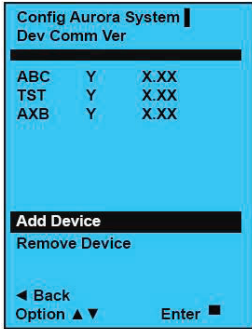

Single and Dual Capacity unit

Y – Active Communication
 N – Device has been found, but communication has failed.

Communicating Thermostat Troubleshooting Guide cont.

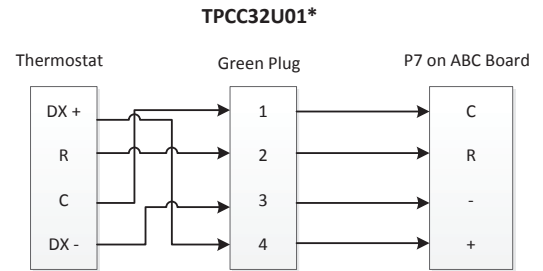
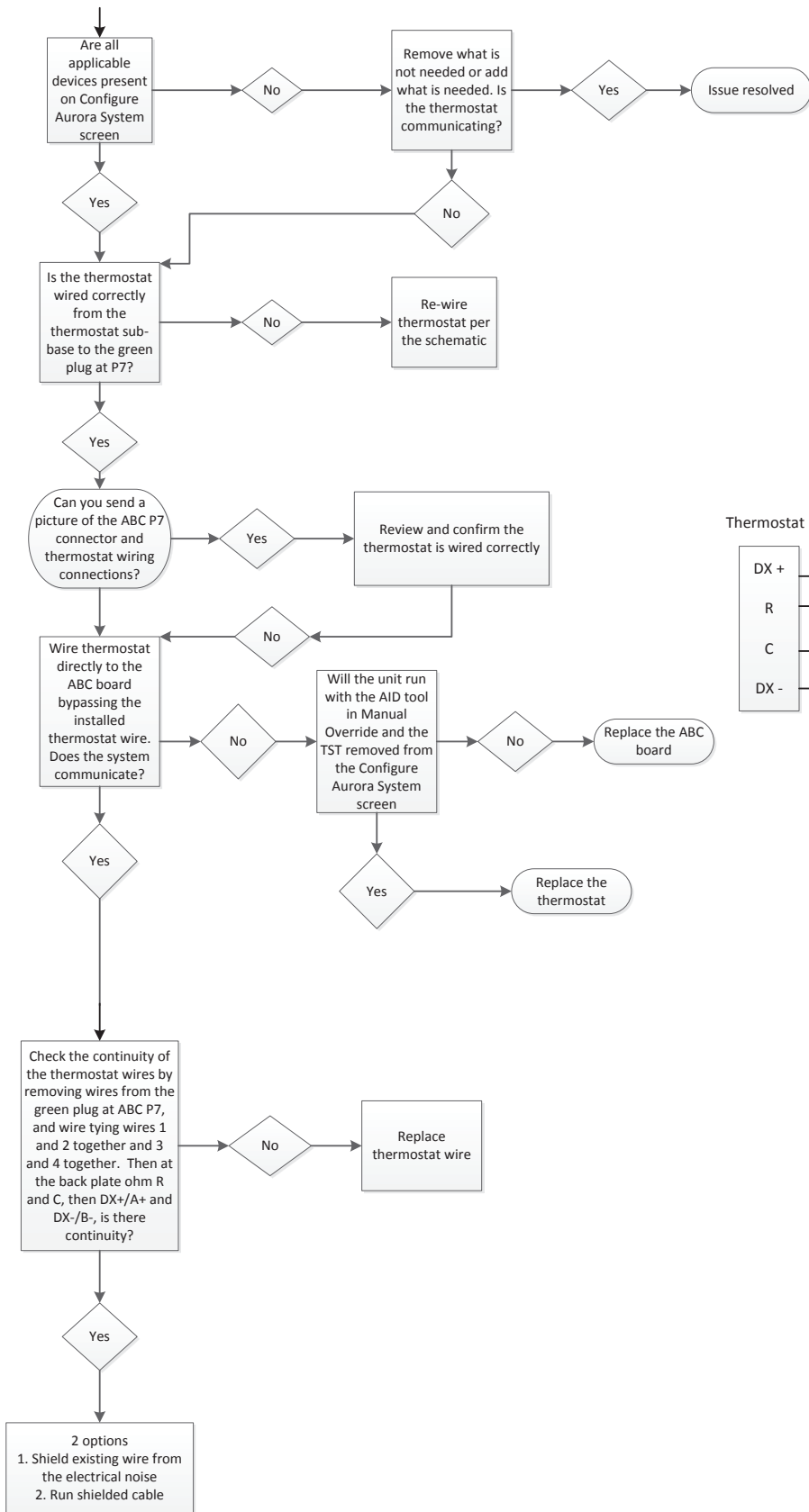

Control Board Signals

To Check for 24VAC between R and C

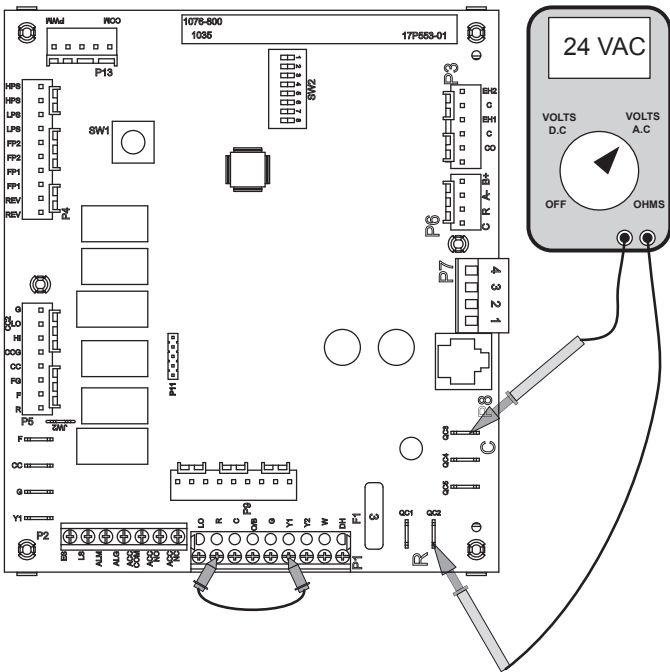

With power applied to the unit connect your Volt meter leads to “R” and “C” on the control board where the yellow and black/white transformer wires connect. The reading should be between 18VAC and 30VAC.

To Check for 24VAC to Compressor Contactor

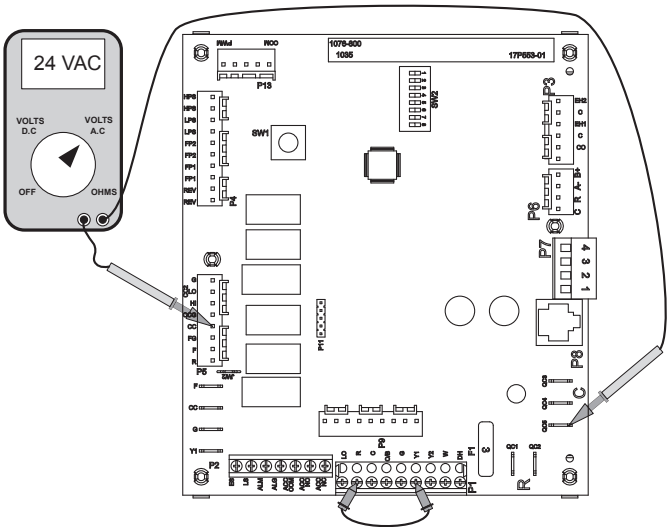

With the AID Tool go to the “Thermostat Inputs” Menu under “Diagnostics” and over-ride the “Y1” input to ON. If an AID Tool is not available remove the P1 connector to disconnect the thermostat from the board and place a jumper wire between “R” and “Y1” as shown. Apply power and put the board into test mode by holding SW1 for 2-5 seconds, the green LED will begin a slow flash. Connect your Volt meter leads to “CC” and “C”. After 1 minute the reading should be between 18 and 30VAC. If you have

a signal and the contactor is not pulled in, check voltage across the contactor coil. If you have voltage across the contractor coil, replace the contactor. If there is no voltage across the contactor coil, verify all wiring between the board and contactor. If you have no voltage between CC and C and the fault LED is not flashing, then replace the board.

To Check Operation of the Reversing Valve Output

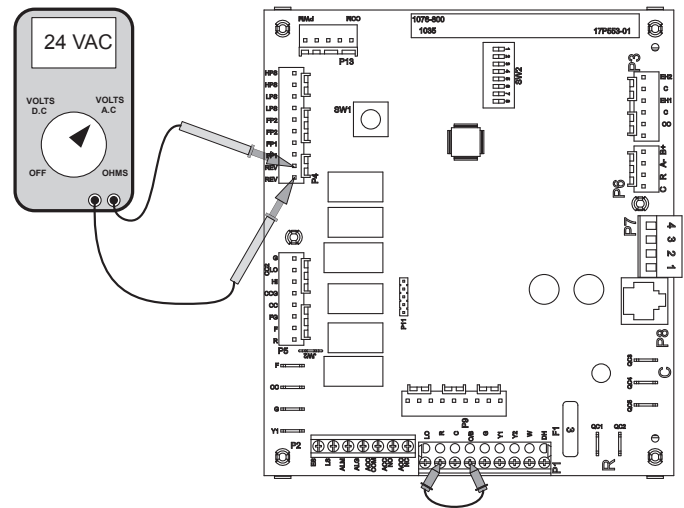

Make sure that SW2-3 is set to “ON”. With the AID Tool go to the “Thermostat Inputs” Menu under “Diagnostics” and over-ride the “O” input to ON. If an AID Tool is not available remove the P1 connector to disconnect the thermostat from the board and place a jumper wire between “R” and “O” as shown. Apply power and put the board into test mode by holding SW1 for 2-5 seconds, the green LED will begin a slow flash. Connect your Volt meter leads to the two “REV” pins on P4. The reading should be between 18 and 30VAC. If you have voltage and the reversing valve is not shifting, check voltage across the coil. If you have voltage across the reversing valve coil, but the valve does not shift the reversing valve coil may be bad. If there is no voltage across the coil, verify all wiring between the board and reversing valve. If no voltage is present on the two REV terminals then replace the board.

Control Board Signals cont.

To Check the Condensate Sensor

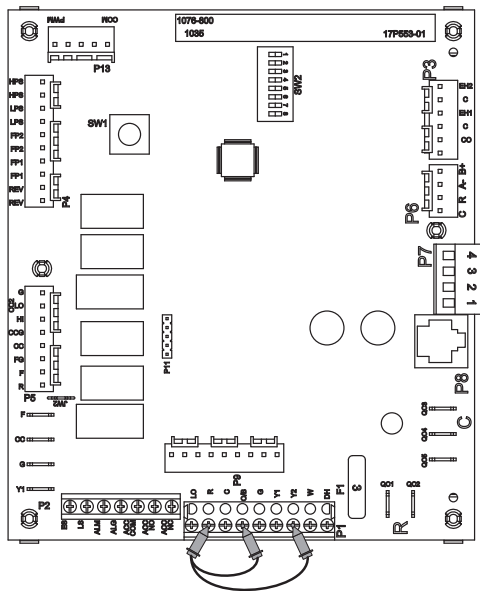

How it works: The condensate sensor is a three part system: a wire, air coil, and water in the drain pan. The wire (spade terminal) and air coil act like a normally open contact and the water acts as the switch. When water in the drain pan fills up and touches the spade terminal, the unit will fault on condensate.

Checking the Sensor: With the AID Tool go to the “Thermostat Inputs” Menu under “Diagnostics” and over-ride the “O” and “Y2” inputs to ON. If an AID Tool is not available remove the P1 connector to disconnect the thermostat from the board and place a jumper wire between “R”, “Y2”, and “O” as shown. Apply power and put the board into test mode by holding SW1 for 2-5 seconds, the green LED will begin a slow flash. Observe the water level in the drain pan. If the unit is locking out on condensate and the drain pan is dry, remove the condensate wire from the drain pan and tape it out of the way. Be careful not to ground the wire out because that will cause the unit to lockout on condensate over flow. If the unit is still locking out, check the brown wire all the way back to the logic board for a short to ground. Remember that the condensate sensor is just a wire looking for a ground. If it touches any metal in the cabinet, the unit will see that as a condensate fault.

If removing the wire from the drain pan stopped the false drain lockouts, put the condensate sensor back in place in the drain pan. Pay close attention to how far the spade terminal sits down in the drain pan. If the terminal is pushed all the way down so that it is touching the bottom of the drain pan, this will cause a condensate lockout if there is any trace of water in the drain pan. If the spade terminal fits loosely in the drain pan, spread the terminal open to make it fit snugly in the drain pan.

To Check the ECM Blower Motor Enable Signal

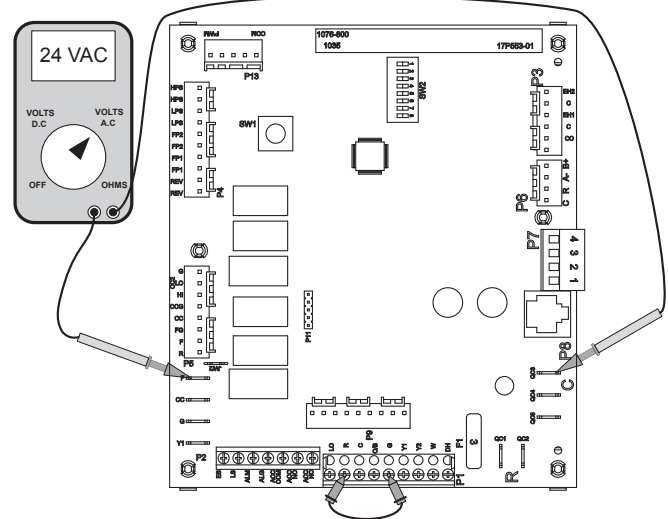

With the AID Tool go to the “Thermostat Inputs” Menu under “Diagnostics” and over-ride the “G” input to ON. If an AID Tool is not available remove the P1 connector to disconnect the thermostat from the board and place a jumper between “R” and “G” as shown. Put the board into test mode by holding SW1 for 2-5 seconds. The blower will come on and run in the “G” speed setting. To check the enable signal to the motor, measure 24VAC between the F and C terminals.

To Check the Electric Heat Outputs

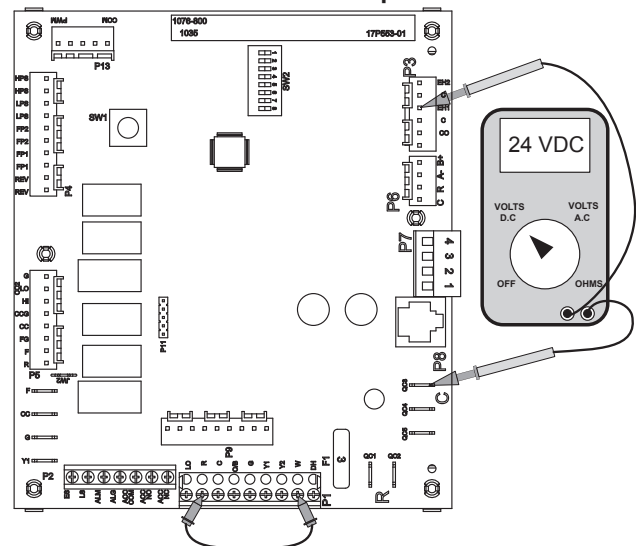

With the AID Tool go to the “Thermostat Inputs” Menu under “Diagnostics” and over-ride the “W” input to ON. If an AID Tool is not available remove the P1 connector to disconnect the thermostat from the board and place a jumper between “R” and “W” as shown. Put the board into test mode by holding SW1 for 2-5 seconds. The blower will come on and run in high speed. 10 seconds later electric heat output 1 (EH1) will be enabled followed by electric heat output 2 (EH2) in 7.5 seconds. Check EH1 by measuring DC volts between “C” and “EH1” and check EH2 by measuring DC volts between “C” and “EH2”.

Jumping the Control Board

Stage 1 Heating

With the AID Tool go to the “Thermostat Inputs” Menu under “Diagnostics” and over-ride the “Y1” input to ON. If an AID Tool is not available remove the P1 connector to disconnect the thermostat from the board. Place a jumper between the “R” and “Y1” terminals as shown.

The blower motor will start in “G” blower speed setting immediately the compressor will start 10 seconds later. If the unit is equipped with an ECM blower motor it will switch to low speed 15 seconds after the Y1 input.

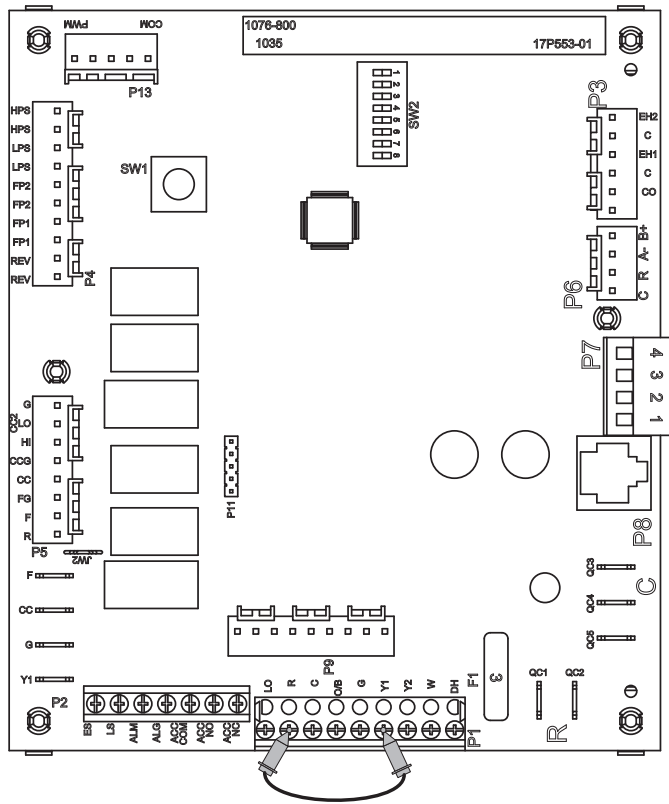

Stage 2 Heating

With the AID Tool go to the “Thermostat Inputs” Menu under “Diagnostics” and over-ride the “Y1” and “Y2” inputs to ON. If an AID Tool is not available remove the P1 connector to disconnect the thermostat from the board. Place a jumper between the R, Y1, and Y2 terminals as shown.

The blower motor will start in “G” blower speed setting immediately the compressor will start 10 seconds later. If the unit is equipped with an ECM blower motor it will switch to low speed 15 seconds after the Y1 input. The compressor will stage to full capacity 20 seconds after the compressor starts, and the blower will change to high speed.

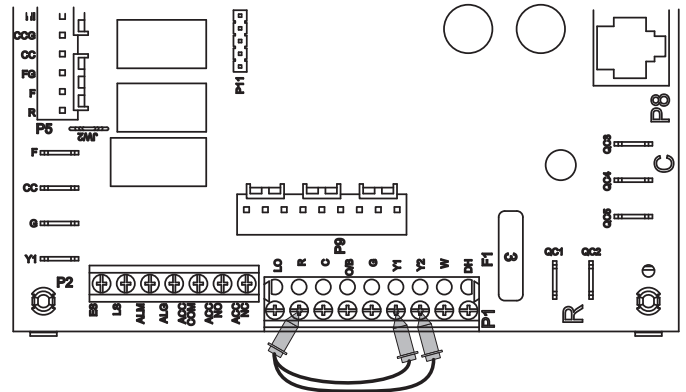

Stage 3 Heating

With the AID Tool go to the “Thermostat Inputs” Menu under “Diagnostics” and over-ride the “Y1”, “Y2”, and “W” inputs to ON. If an AID Tool is not available remove the P1 connector to disconnect the thermostat from the board. Place a jumper between the R, Y1, Y2 and W terminals as shown.

The blower motor will start in “G” blower speed setting immediately the compressor will start 10 seconds later. If the unit is equipped with an ECM blower motor it will switch to low speed 15 seconds after the Y1 input. The compressor will stage to full capacity 20 seconds after the compressor starts, and the blower will change to high speed. The first stage of resistance heat is energized and with continuous third stage demand the second stage of resistance heat will engage in 5 minutes.

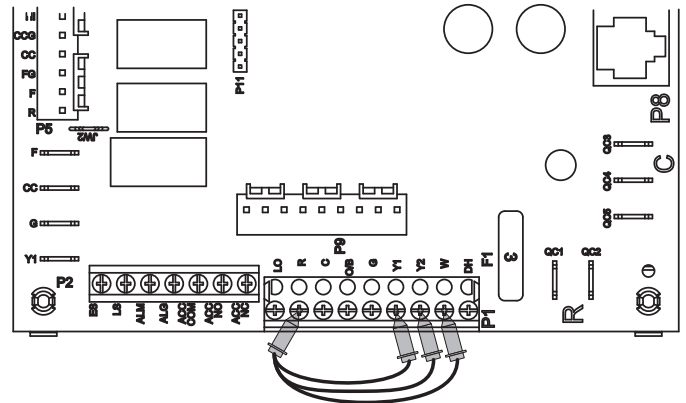

Jumping the Control Board cont.

Emergency Heat

With the AID Tool go to the “Thermostat Inputs” Menu under “Diagnostics” and over-ride the “W” input to ON. If an AID Tool is not available remove the P1 connector to disconnect the thermostat from the board. Place a jumper between the “R” and “W” terminals as shown.

The blower will start on high speed and after 20 seconds the first stage of resistance heat is energized. Continuing demand will engage the second stage after 2 minutes.

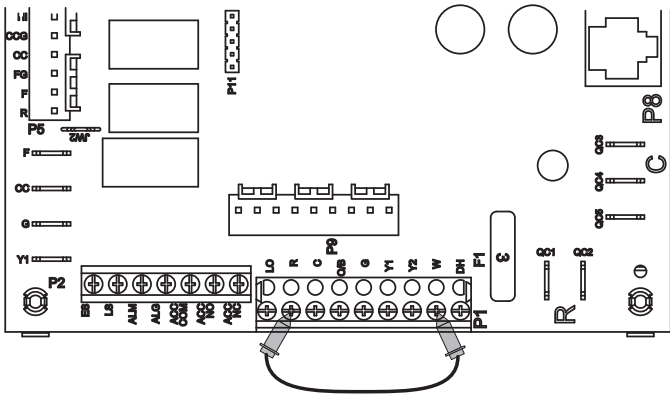

Blower Only

With the AID Tool go to the “Thermostat Inputs” Menu under “Diagnostics” and over-ride the “G” input to ON. If an AID Tool is not available remove the P1 connector to disconnect the thermostat from the board. Place a jumper between the “R” and “G” terminals as shown.

The blower will start on the “G” speed setting. Also, regardless of blower speed setting, the blower will remain on for 30 seconds at the end of each heating, cooling, emergency heat, or reheat cycle.

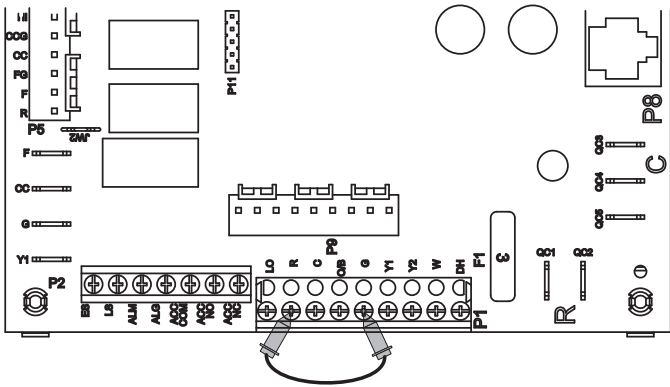

Stage 1 Cooling

With the AID Tool go to the “Thermostat Inputs” Menu under “Diagnostics” and over-ride the “Y1” and “O” inputs to ON. If an AID Tool is not available remove the P1 connector to disconnect the thermostat from the board. Place a jumper between the R, O, and Y1 terminals as shown.

The blower motor will start in “G” blower speed setting immediately, the compressor will start 10 seconds later. If the unit is equipped with an ECM blower motor it will switch to low speed 15 seconds after the Y1 input.

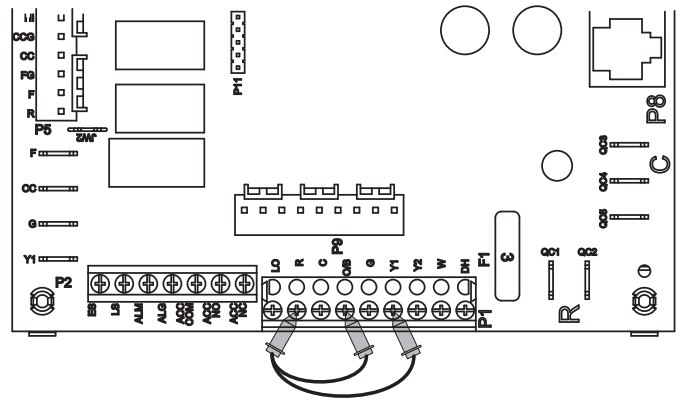

Stage 2 Cooling

With the AID Tool go to the “Thermostat Inputs” Menu under “Diagnostics” and over-ride the “Y1”, “Y2”, and “O” inputs to ON. If an AID Tool is not available remove the P1 connector to disconnect the thermostat from the board. Place a jumper between the R, O, Y1, and Y2 terminals as shown.

The blower motor will start in “G” blower speed setting immediately the compressor will start 10 seconds later. If the unit is equipped with an ECM blower motor it will switch to low speed 15 seconds after the Y1 input. The compressor will stage to full capacity 20 seconds after the compressor starts, and the blower will change to high speed.

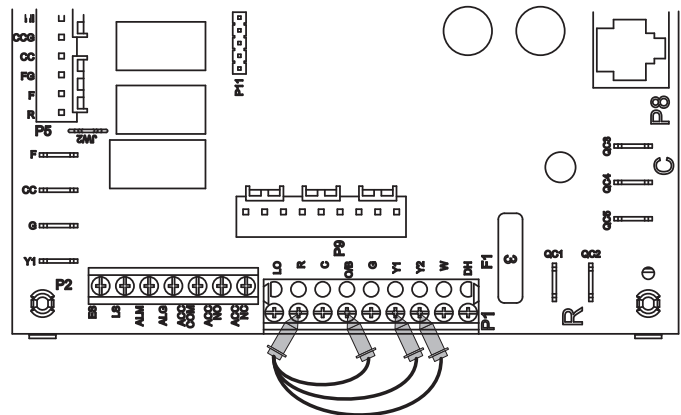

Jumping the Control Board cont.

Reheat Mode

With the AID Tool go to the “Thermostat Inputs” Menu under “Diagnostics” and over-ride the “DH” input to ON. If an AID Tool is not available remove the P1 connector to disconnect the thermostat from the board. Place a jumper between the R and DH terminals as shown.

The blower motor will start in “G” blower speed setting immediately the compressor will start 10 seconds later. If the unit is equipped with an ECM blower motor it will switch to low speed 15 seconds after the DH input. 20 seconds after the DH input is received the compressor will switch to full capacity and the blower motor will switch to dehumidification high speed. 30 seconds after the compressor starts the alarm/reheat output will energize.

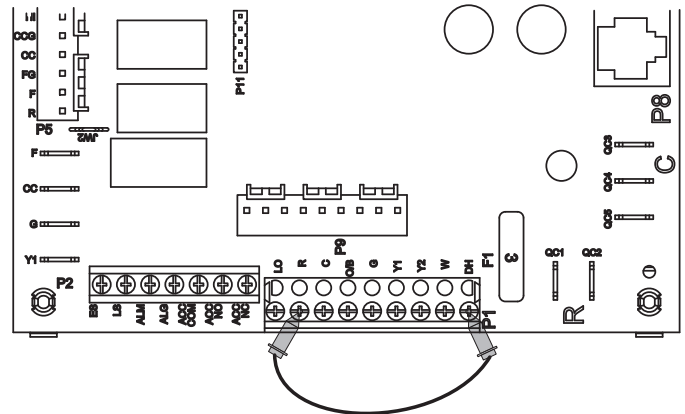

Water Side Analysis: Heat of Extraction/Rejection

By determining the amount of heat extracted or rejected, the service technician can better judge the performance of the unit and verify whether or not the unit performance is acceptable. Use the following formula to find the heat of extraction/rejection.

HEAT OF EXTRACTION/REJECTION

$Q = \text{FLOW} \times \text{FLUID FACTOR} \times \text{TEMP DIFF}$

FLOW = gpm

TEMP DIFF = Water Rise or Drop in Fahrenheit degrees across the coax

500 = FLUID FACTOR used for water

485 = FLUID FACTOR used for antifreeze solution

Example: Entering water temperature of 50°F, leaving water temperature 60.1°F, entering water pressure of 40 psi, leaving water pressure of 34.2 psi, entering air temperature of 70°F, and closed loop (485).

$\Delta P = 40 \text{ psi} - 34.2 \text{ psi}$

$\Delta P = 5.8 \text{ psi}$

Convert ΔP to psi using pressure drop table in equipment install manual. A ΔP of 5.8 psi equals 9 gpm.

$Q = 9 \text{ gpm} \times 485 \times 10.1^\circ\text{F}$

$Q = 44,087 \text{ Btu/hr}$

Next, find the Heat of Extraction/Rejection Data for the example unit. Match the entering water temperature at 9 gpm. Now, move to the right and read the number under "HR" and compare listed capacity data with actual performance. Note that the example calculation is within 4,800 Btu/hr of the listed HE. The actual heat of extraction/rejection should be within 10% of catalog data. If the actual heat of extraction/rejection is less than 90% of catalog data, a further refrigeration check of the unit will be necessary to determine if the unit is charged properly, has a faulty component, or needs adjustment.

Example Unit Data Tables

Pressure Drop

Model	gpm	Pressure Drop (psi)				
		30°F	50°F	70°F	90°F	110°F
Example	5.0	1.4	1.1	0.9	0.7	0.5
	7.0	2.5	2.3	2.1	1.8	1.6
	9.0	6.0	5.8	5.5	5.3	5.1
	12.0	6.6	6.4	6.2	6.0	5.7

Heat of Extraction/Rejection

Model	gpm	Heat of Extraction (HE)				Heat of Rejection (HR)				
		30°F	50°F	70°F	90°F	30°F	50°F	70°F	90°F	110°F
Example	5.0		24.6	33.0	41.7		47.4	45.3	44.1	
	7.0	19.0	25.7	34.3	42.4	41.5	47.7	45.8	44.2	42.4
	9.0	19.6	26.8	35.5	43.1	41.7	48.1	46.3	44.6	42.7

Superheat/Subcooling

Checking Superheat in the Heating Mode

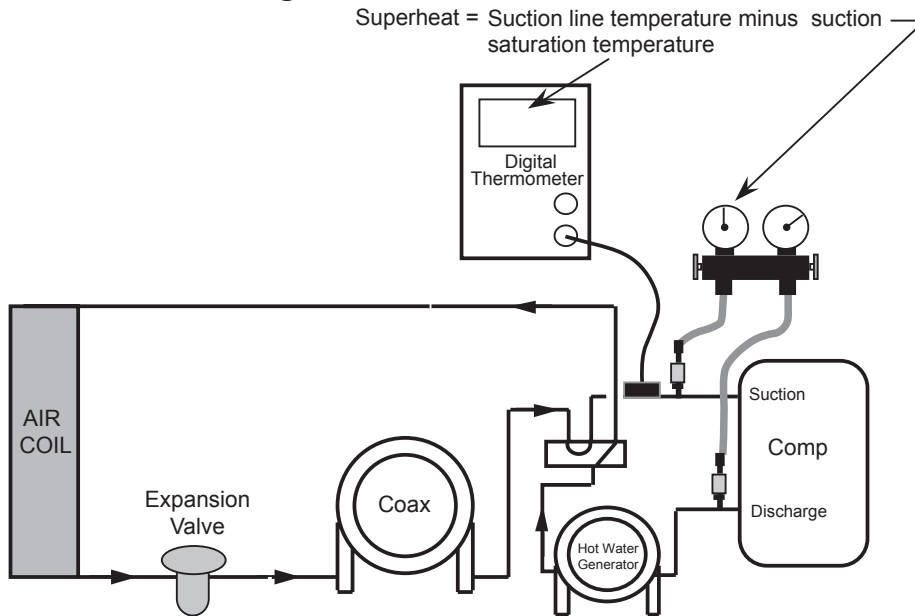

Checking Superheat in the Cooling Mode

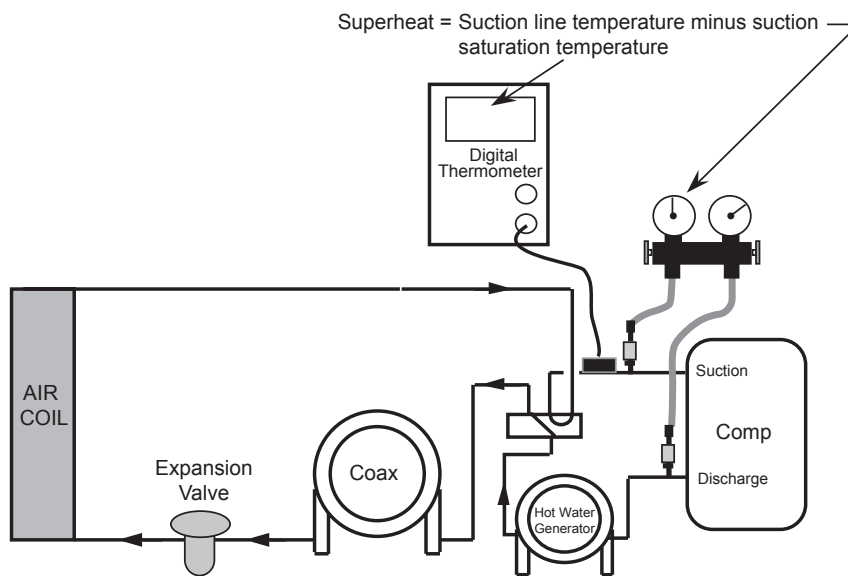

NOTE: Always turn hot water generator off during these tests.

1. Always check water and airflow before putting gages on the unit.
2. Determine superheat and compare with the values shown in the table.
3. If superheat is HIGH, there may be a restriction in the TXV assembly, low charge, or the TXV bulb may have lost its charge. Also check entering air and water temperatures.
4. If superheat is HIGH and subcooling is LOW, the unit may be undercharged.

Entering Water Temperature	Heating		Cooling	
	Superheat	Subcooling	Superheat	Subcooling
030	9-14	5-9	25-35	15-25
050	10-14	5-9	10-18	15-25
070	12-16	5-8	9-14	13-18
090	N/A	N/A	8-13	13-18

Based on nominal 400 cfm per ton airflow and 80°F EAT cooling and 70°F EAT heating. Cooling air and water numbers can vary greatly with changes in humidity.

Superheat/Subcooling cont.

Checking Subcooling in the Heating Mode

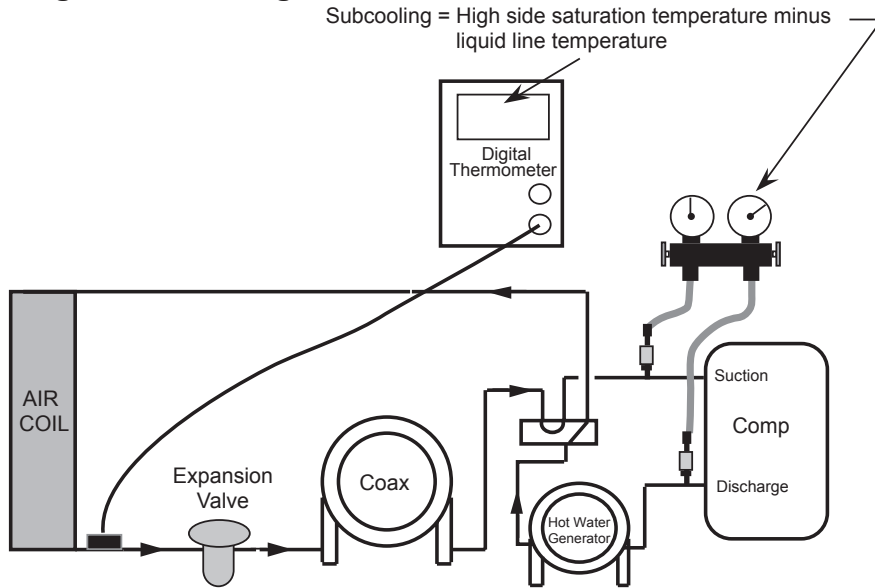

Checking Subcooling in the Cooling Mode

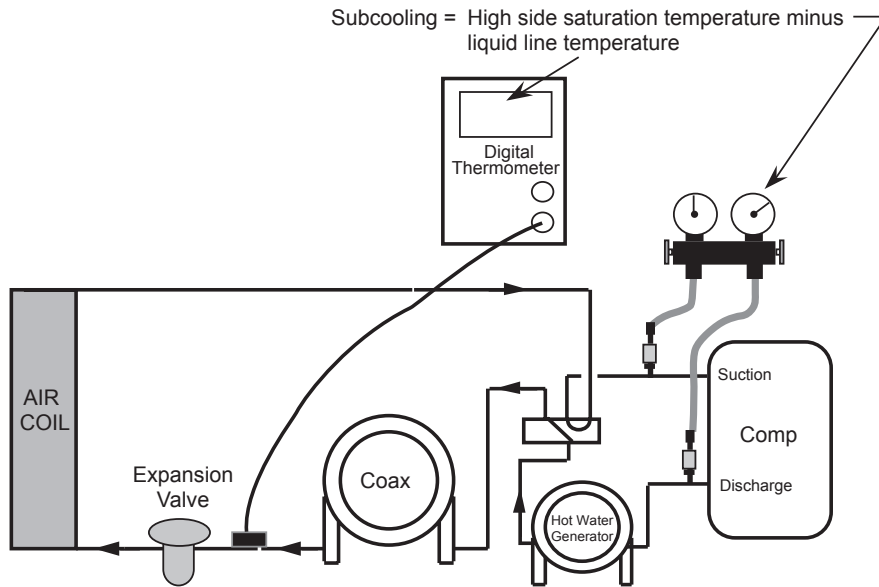

NOTE: Always turn hot water generator off during these tests.

1. Always check water and airflow before putting gages on the unit.
2. Determine subcooling and compare with the values shown in the table.
3. If superheat is HIGH, there may be a restriction in the TXV assembly, low charge, or the TXV bulb may have lost its charge. Also check entering air and water temperatures.
4. If superheat is HIGH and subcooling is LOW, the unit may be undercharged.

Entering Water Temperature	Heating		Cooling	
	Superheat	Subcooling	Superheat	Subcooling
030	9-14	5-9	25-35	15-25
050	10-14	5-9	10-18	15-25
070	12-16	5-8	9-14	13-18
090	N/A	N/A	8-13	13-18

Based on nominal 400 cfm per ton airflow and 80°F EAT cooling and 70°F EAT heating. Cooling air and water numbers can vary greatly with changes in humidity.

Troubleshooting

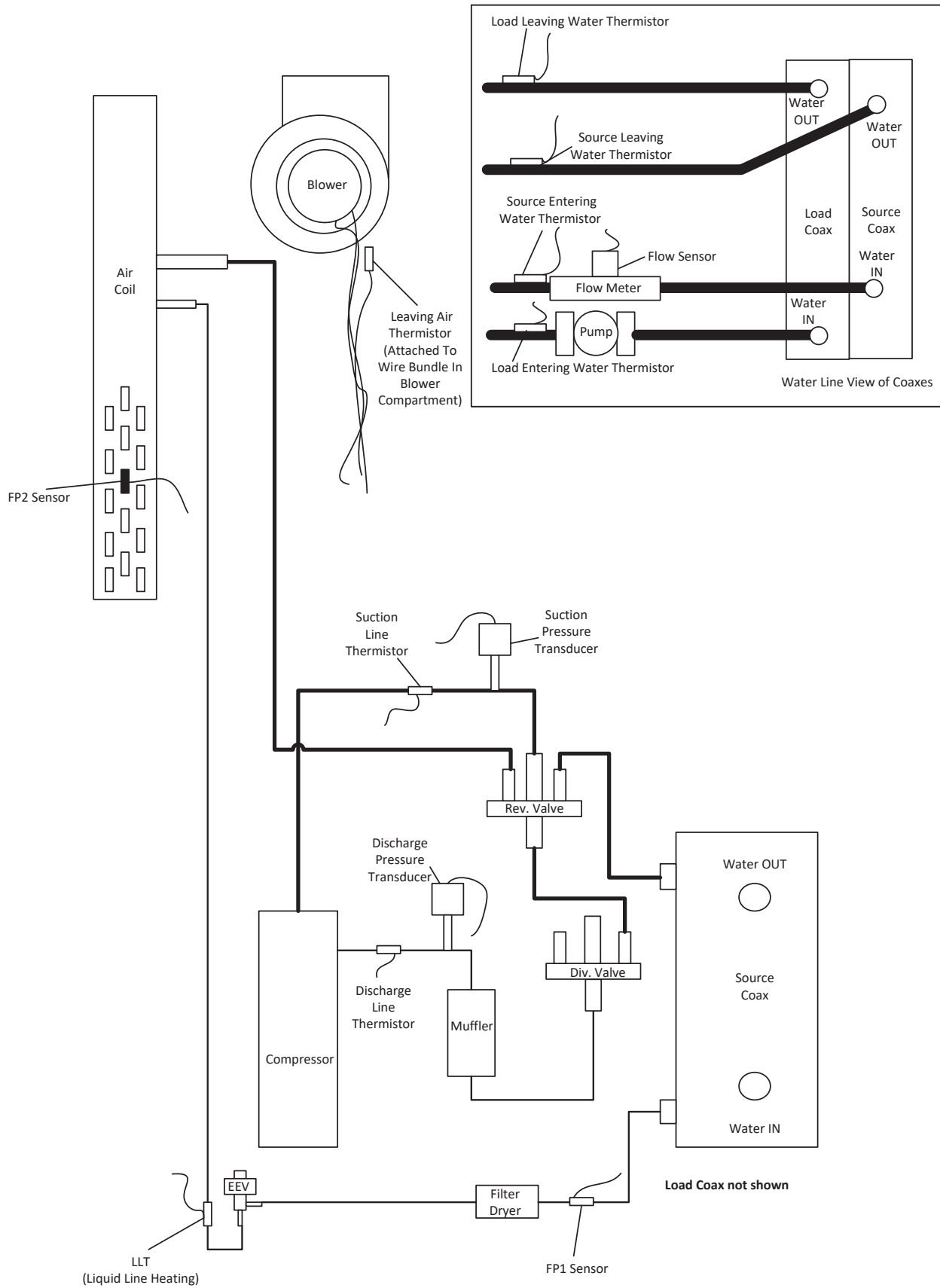

Troubleshooting cont.

Startup/Troubleshooting Form

Dealer: _____
 Phone #: _____ Date: _____
 Problem: _____
 Model #: _____
 Serial #: _____

Controls Info:
 ABC Version: _____
 AXB Version: _____
 IZ2 Version: _____
 T-Stat Version: _____
 Installed Sensors: _____

COOLING CYCLE ANALYSIS

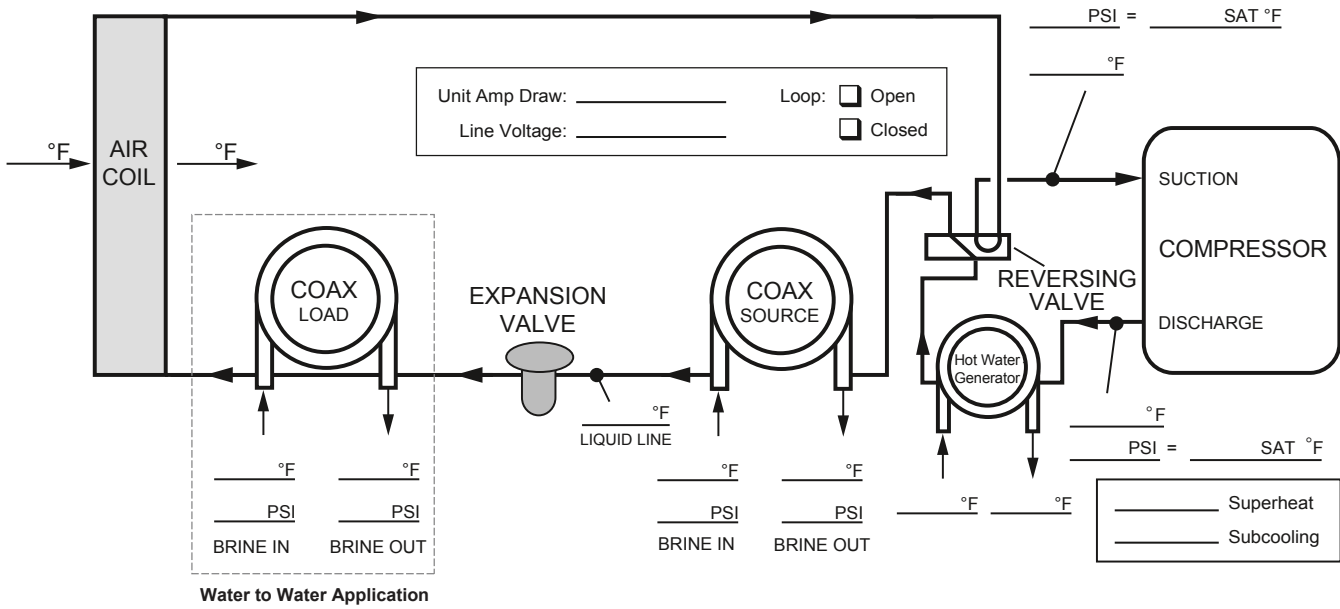

Heat of Extraction/Rejection = gpm x 500 (485 for water/antifreeze) x ΔT

Note: DO NOT hook up pressure gauges unless there appears to be a performance problem.

HEATING CYCLE ANALYSIS

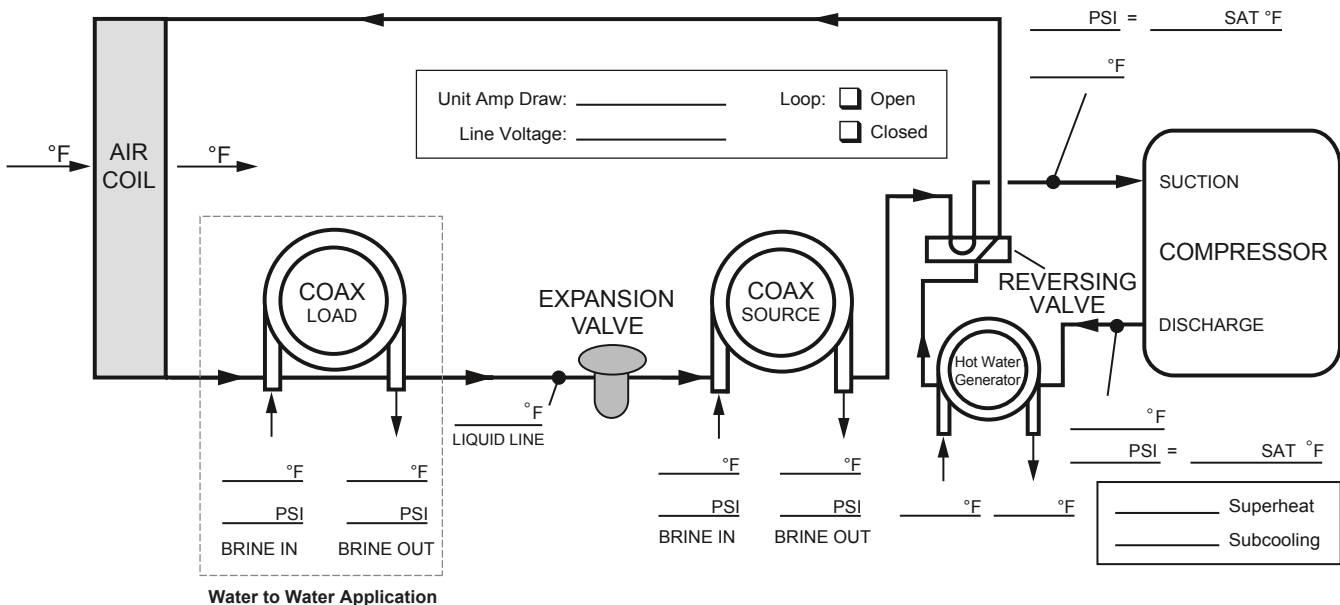

Troubleshooting cont.

Single Speed/Dual Capacity Startup/Troubleshooting Form

1. Job Information

Model # _____ Job Name: _____ Loop: Open / Closed
 Serial # _____ Install Date: _____ Hot Water Generator: Y / N

2. Flow Rate in gpm

	SOURCE COAX		LOAD COAX (Water-to-Water)	
	HEATING	COOLING	HEATING	COOLING
WATER IN Pressure:	a. _____ psi	a. _____ psi	a. _____ psi	a. _____ psi
WATER OUT Pressure:	b. _____ psi	b. _____ psi	b. _____ psi	b. _____ psi
Pressure Drop: a - b	c. _____ psi	c. _____ psi	c. _____ psi	c. _____ psi
Look up flow rate in table:	d. _____ gpm	d. _____ gpm	d. _____ gpm	d. _____ gpm

3. Temp. Rise/Drop Across Coaxial Heat Exchanger¹

	SOURCE COAX		LOAD COAX (Water-to-Water)	
	HEATING	COOLING	HEATING	COOLING
WATER IN Temperature:	e. _____ °F	e. _____ °F	h. _____ °F	h. _____ °F
WATER OUT Temperature:	f. _____ °F	f. _____ °F	i. _____ °F	i. _____ °F
Temperature Difference:	g. _____ °F	g. _____ °F	j. _____ °F	j. _____ °F

4. Temp. Rise/Drop Across Air Coil

	SOURCE COAX	
	HEATING	COOLING
SUPPLY AIR Temperature:	h. _____ °F	h. _____ °F
RETURN AIR Temperature:	i. _____ °F	i. _____ °F
Temperature Difference:	j. _____ °F	j. _____ °F

5. Heat of Rejection (HR)/Heat of Extraction (HE)

Brine Factor²: k. _____
 HR/HE = d x g x k
 HEATING COOLING
 l. _____ Btu/h l. _____ Btu/h

STEPS 6-9 NEED ONLY BE COMPLETED IF A PROBLEM IS SUSPECTED.

6. Watts

	ENERGY MONITOR	
	HEATING	COOLING
Volts:	m. _____ Volts	m. _____ Volts
Total Amps (Comp. + Blower) ³ :	n. _____ Amps	n. _____ Amps
Watts = m x n x 0.85:	o. _____ Watts	o. _____ Watts

7. Capacity

	HEATING	COOLING
	Cooling Capacity = l - (o x 3.413):	p. _____ Btu/h
Heating Capacity = l + (o x 3.413):		

8. Efficiency

	HEATING	COOLING
	Cooling EER = p / o:	q. _____ Btu/h
Heating COP = p / (o x 3.413):		

9. Superheat (S.H.)/Subcooling (S.C.)

	HEATING	COOLING
	Suction Pressure:	r. _____ psi
Suction Saturation Temperature:	s. _____ °F	s. _____ °F
Suction Line Temperature:	t. _____ °F	t. _____ °F
S.H. = t - s	u. _____ °F	u. _____ °F
Head Pressure:	v. _____ psi	v. _____ psi
High Pressure Saturation Temp:	w. _____ °F	w. _____ °F
Liquid Line Temperature ⁴ :	x. _____ °F	x. _____ °F
S.C. = w - x	y. _____ °F	y. _____ °F

Software Version
ABC: _____
AXB: _____
IZZ: _____
T'STAT: _____

NOTES: ¹ Steps 3-9 should be conducted with the hot water generator disconnected.
² Use 500 for pure water, 485 for methanol or Environol™. (This constant is derived by multiplying the weight of one gallon of water (8.34) times the minutes in one hour (60) times the specific heat of the fluid. Water has a specific heat of 1.0.
³ If there is only one source of power for the compressor and blower, amp draw can be measured at the source wiring connection.
⁴ Liquid line is between the coax and the expansion device in the cooling mode; between the air coil and the expansion device in the heating mode.

Performance Data

036 High Speed

EWT °F	Flow gpm	WPD		HEATING - EAT 70°F							COOLING - EAT 80/67 °F							
		PSI	FT	Airflow cfm	HC MBtu/h	Power kW	HE MBtu/h	LAT °F	COP	HWC MBtu/h	Airflow cfm	TC MBtu/h	SC MBtu/h	S/T Ratio	Power kW	HR MBtu/h	EER	HWC MBtu/h
20	5.0	2.6	5.9	Operation not recommended							Operation not recommended							
	7.0	4.0	9.2	Operation not recommended							Operation not recommended							
	9.0	5.5	12.7	1050 1250	25.0 25.4	2.21 2.19	17.4 17.9	92.0 88.8	3.31 3.40	2.8 2.5								
30	5.0	2.5	5.8	Operation not recommended							Operation not recommended							
	7.0	3.9	8.9	1050 1250	27.7 28.5	2.15 2.22	20.4 21.0	94.4 91.1	3.78 3.77	2.9 2.7	1050 1250	32.1 32.7	19.9 21.8	0.62 0.67	1.18 1.24	36.2 36.9	27.3 26.3	- -
	9.0	5.3	12.3	1050 1250	28.6 29.1	2.26 2.24	20.9 21.5	95.2 91.6	3.71 3.81	3.0 2.8	1050 1250	32.3 33.1	19.9 21.8	0.62 0.66	1.14 1.20	36.2 37.2	28.3 27.6	- -
40	5.0	2.4	5.6	Operation not recommended							Operation not recommended							
	7.0	3.7	8.7	1050 1250	31.7 32.7	2.25 2.29	24.1 24.9	98.0 94.2	4.14 4.18	3.4 3.1	1050 1250	36.5 37.2	24.0 26.2	0.66 0.70	1.39 1.46	41.3 42.2	26.2 25.4	- -
	9.0	5.2	12.0	1050 1250	32.4 33.4	2.27 2.32	24.6 25.5	98.5 94.7	4.19 4.23	3.5 3.1	1050 1250	36.8 37.6	24.0 26.2	0.65 0.70	1.35 1.42	41.4 42.4	27.2 26.6	- -
50	5.0	2.3	5.4	1050 1250	34.5 35.5	2.29 2.32	26.7 27.6	100.4 96.3	4.42 4.49	3.6 3.3	1050 1250	38.8 40.8	25.4 28.3	0.66 0.69	1.69 1.78	44.5 46.9	23.0 23.0	1.7 1.8
	7.0	3.6	8.4	1050 1250	35.8 36.9	2.34 2.37	27.8 28.8	101.5 97.3	4.48 4.56	3.7 3.4	1050 1250	39.6 41.6	25.7 28.6	0.65 0.69	1.59 1.67	45.0 47.3	24.9 24.9	1.6 1.8
	9.0	5.0	11.6	1050 1250	36.6 37.7	2.36 2.39	28.5 29.5	102.2 97.9	4.54 4.62	3.8 3.5	1050 1250	40.0 42.1	27.5 30.5	0.69 0.72	1.55 1.63	45.3 47.7	25.8 25.8	1.5 1.7
60	5.0	2.3	5.3	1050 1250	37.7 38.9	2.36 2.38	29.6 30.8	103.2 98.8	4.67 4.79	4.1 3.8	1050 1250	37.9 39.8	25.3 28.2	0.67 0.71	1.89 1.97	44.4 46.5	20.1 20.2	2.1 2.2
	7.0	3.5	8.1	1050 1250	39.4 40.6	2.43 2.44	31.1 32.3	104.7 100.1	4.75 4.87	4.2 3.9	1050 1250	38.8 40.7	25.6 28.4	0.66 0.70	1.80 1.87	45.0 47.1	21.6 21.8	2.0 2.1
	9.0	4.9	11.2	1050 1250	40.3 41.7	2.45 2.47	31.9 33.2	105.6 100.9	4.81 4.95	4.3 4.0	1050 1250	39.2 41.2	27.0 30.0	0.69 0.73	1.75 1.83	45.2 47.4	22.4 22.5	1.8 2.0
70	5.0	2.2	5.1	1050 1250	18.2 42.9	2.44 2.47	39.9 34.5	100.1 101.8	2.19 5.09	4.7 4.3	1050 1250	37.1 39.6	25.2 29.6	0.68 0.75	2.07 2.17	40.3 46.8	18.5 18.2	2.6 2.8
	7.0	3.4	7.9	1050 1250	43.0 44.4	2.52 2.52	34.4 35.8	107.9 102.9	5.00 5.16	4.8 4.4	1050 1250	38.1 39.7	25.5 28.3	0.67 0.71	2.00 2.07	44.9 47.0	19.0 19.2	2.4 2.6
	9.0	4.7	10.9	1050 1250	44.1 45.6	2.55 2.54	35.4 36.9	108.9 103.8	5.07 5.26	5.0 5.6	1050 1250	38.5 40.2	26.5 29.4	0.69 0.73	1.95 2.03	45.1 47.1	19.7 19.8	2.3 2.5
80	5.0	2.1	4.9	1050 1250	44.2 45.7	2.52 2.50	35.6 37.2	108.9 103.9	5.14 5.37	5.2 4.8	1050 1250	35.5 36.9	24.8 27.5	0.70 0.75	2.31 2.38	43.3 45.0	15.3 15.5	3.2 3.4
	7.0	3.3	7.6	1050 1250	46.7 48.3	2.61 2.59	37.8 39.5	111.2 105.8	5.23 5.47	5.3 4.9	1050 1250	36.4 37.9	25.1 27.8	0.69 0.73	2.23 2.30	44.0 45.7	16.3 16.5	3.0 3.3
	9.0	4.5	10.5	1050 1250	48.1 49.7	2.65 2.61	39.0 40.8	112.4 106.8	5.32 5.58	5.5 5.1	1050 1250	36.8 38.4	25.7 28.5	0.70 0.74	2.18 2.25	44.3 46.0	16.9 17.0	2.8 3.1
90	5.0	2.0	4.7	1050 1250	47.4 49.1	2.59 2.55	38.6 40.4	111.8 106.4	5.36 5.64	5.9 5.4	1050 1250	33.8 35.0	24.3 27.0	0.72 0.77	2.53 2.59	42.4 43.9	13.4 13.5	4.0 4.3
	7.0	3.2	7.3	1050 1250	50.4 52.2	2.71 2.66	41.2 43.1	114.5 108.7	5.45 5.75	6.0 5.6	1050 1250	34.8 36.1	24.6 27.3	0.71 0.76	2.46 2.52	43.2 44.7	14.2 14.3	3.7 4.1
	9.0	4.4	10.1	1050 1250	52.0 53.8	2.75 2.68	42.6 44.7	115.9 109.9	5.55 5.88	6.2 5.8	1050 1250	35.8 36.5	25.4 27.5	0.71 0.75	2.41 2.47	44.0 44.9	14.9 14.8	3.5 3.9
100	5.0	2.0	4.6	Operation not recommended							Operation not recommended							
	7.0	3.1	7.1	Operation not recommended							Operation not recommended							
	9.0	4.2	9.8	Operation not recommended							1050 1250	32.7 33.8	24.2 26.9	0.74 0.79	2.76 2.80	42.1 43.4	11.9 12.1	4.6 5.0
110	5.0	1.9	4.4	Operation not recommended							Operation not recommended							
	7.0	2.9	6.8	Operation not recommended							Operation not recommended							
	9.0	4.1	9.4	Operation not recommended							1050 1250	30.6 31.5	23.8 26.4	0.78 0.84	3.06 3.08	41.1 42.0	10.0 10.2	5.6 6.1
120	5.0	1.8	4.2	Operation not recommended							Operation not recommended							
	7.0	2.8	6.5	Operation not recommended							Operation not recommended							
	9.0	3.9	9.0	Operation not recommended							1050 1250	28.6 29.2	23.4 25.4	0.82 0.87	3.39 3.47	40.2 41.0	8.5 8.4	6.8 7.4
											1050 1250	28.9 29.5	23.4 25.4	0.81 0.86	3.28 3.38	40.1 41.0	8.8 8.7	6.3 7.0

Performance Data

036 Low Speed

EWT °F	Flow gpm	WPD		HEATING - EAT 70°F							COOLING - EAT 80/67 °F							
		PSI	FT	Airflow cfm	HC MBtu/h	Power kW	HE MBtu/h	LAT °F	COP	HWC MBtu/h	Airflow cfm	TC MBtu/h	SC MBtu/h	S/T Ratio	Power kW	HR MBtu/h	EER	HWC MBtu/h
20	4.0	2.0	4.7	Operation not recommended							Operation not recommended							
	6.0	3.2	7.3	Operation not recommended							Operation not recommended							
	8.0	4.6	10.6	900 1050	17.0 17.5	1.73 1.70	11.1 11.7	87.5 85.4	2.88 3.02	2.4 2.2								
30	4.0	2.0	4.6	Operation not recommended							Operation not recommended							
	6.0	3.1	7.1	900 1050	19.5 20.1	1.64 1.69	13.9 14.3	90.1 87.7	3.48 3.48	2.3 2.1	900 1050	26.1 26.5	16.6 18.1	0.63 0.68	0.83 0.88	29.0 29.5	31.3 30.2	- -
	8.0	4.5	10.3	900 1050	19.9 20.5	1.74 1.71	14.0 14.7	90.5 88.1	3.35 3.51	2.4 2.2	900 1050	26.3 26.9	16.6 18.1	0.63 0.67	0.81 0.85	29.0 29.8	32.4 31.6	- -
40	4.0	1.9	4.5	Operation not recommended							Operation not recommended							
	6.0	3.0	6.9	900 1050	22.2 22.9	1.65 1.69	16.6 17.2	92.9 90.2	3.94 3.98	2.5 2.3	900 1050	28.4 29.0	19.3 21.1	0.68 0.73	0.92 0.96	31.6 32.2	31.0 30.1	- -
	8.0	4.3	10.0	900 1050	22.7 23.4	1.67 1.71	17.0 17.6	93.3 90.6	3.98 4.02	2.6 2.4	900 1050	28.7 29.3	19.3 21.1	0.67 0.72	0.89 0.93	31.7 32.5	32.2 31.5	- -
50	4.0	1.9	4.3	900 1050	24.1 24.8	1.63 1.65	18.5 19.2	94.8 91.9	4.34 4.41	2.6 2.4	900 1050	29.2 30.7	20.0 22.2	0.69 0.72	1.05 1.10	32.8 34.5	27.9 27.9	0.9 1.0
	6.0	2.9	6.7	900 1050	24.9 25.7	1.66 1.69	19.3 20.0	95.7 92.7	4.40 4.48	2.7 2.5	900 1050	29.8 31.4	20.2 22.5	0.68 0.72	0.99 1.03	33.2 34.9	30.2 30.3	0.9 1.0
	8.0	4.2	9.7	900 1050	25.5 26.3	1.68 1.70	19.8 20.5	96.2 93.2	4.45 4.53	2.8 2.5	900 1050	30.1 31.7	21.6 24.0	0.72 0.76	0.96 1.01	33.4 35.1	31.3 31.4	0.8 0.9
60	4.0	1.8	4.2	900 1050	26.5 27.3	1.62 1.63	20.9 21.7	97.2 94.1	4.77 4.90	2.9 2.6	900 1050	28.1 29.4	19.8 22.0	0.70 0.75	1.20 1.26	32.2 33.7	23.3 23.4	1.3 1.3
	6.0	2.8	6.5	900 1050	27.6 28.5	1.67 1.68	21.9 22.8	98.4 95.2	4.85 4.98	3.0 2.7	900 1050	28.7 30.1	20.0 22.2	0.70 0.74	1.14 1.19	32.6 34.2	25.1 25.3	1.2 1.3
	8.0	4.1	9.4	900 1050	28.3 29.3	1.69 1.70	22.6 23.5	99.1 95.8	4.92 5.06	3.0 2.8	900 1050	29.0 30.5	21.1 23.4	0.73 0.77	1.11 1.17	32.8 34.4	26.0 26.1	1.1 1.2
70	4.0	1.8	4.0	900 1050	18.2 30.2	1.62 1.70	22.7 24.4	98.7 96.6	3.29 5.21	3.2 2.9	900 1050	27.0 28.6	19.6 22.6	0.73 0.79	1.39 1.46	30.2 33.4	28.7 19.6	1.7 1.8
	6.0	2.7	6.2	900 1050	30.4 31.4	1.68 1.68	24.6 25.6	101.2 97.6	5.31 5.48	3.3 3.0	900 1050	27.7 28.9	19.8 21.9	0.72 0.76	1.30 1.35	32.1 33.6	21.3 21.4	1.6 1.8
	8.0	3.9	9.1	900 1050	31.1 32.2	1.70 1.69	25.3 26.4	102.0 98.4	5.38 5.58	3.4 3.1	900 1050	27.9 29.2	20.6 22.8	0.74 0.78	1.27 1.32	32.3 33.7	22.0 22.1	1.5 1.7
80	4.0	1.7	3.9	900 1050	31.1 32.2	1.61 1.60	25.7 26.8	102.0 98.4	5.67 5.92	3.6 3.3	900 1050	25.5 26.5	19.4 21.5	0.76 0.81	1.57 1.62	30.9 32.1	16.2 16.4	2.4 2.6
	6.0	2.6	6.0	900 1050	32.9 34.1	1.67 1.66	27.2 28.4	103.9 100.0	5.77 6.02	3.7 3.4	900 1050	26.2 27.3	19.6 21.7	0.75 0.80	1.52 1.56	31.4 32.6	17.3 17.5	2.3 2.5
	8.0	3.8	8.8	900 1050	33.9 35.1	1.70 1.67	28.1 29.4	104.9 100.9	5.86 6.15	3.8 3.5	900 1050	26.5 27.6	20.1 22.3	0.76 0.81	1.49 1.53	31.6 32.8	17.8 18.0	2.1 2.3
90	4.0	1.6	3.8	900 1050	33.4 34.6	1.60 1.57	28.0 29.2	104.4 100.5	6.14 6.45	4.0 3.7	900 1050	24.1 24.9	19.2 21.3	0.80 0.85	1.78 1.83	30.2 31.2	13.5 13.6	3.2 3.4
	6.0	2.5	5.8	900 1050	35.5 36.8	1.67 1.64	29.8 31.2	106.5 102.4	6.24 6.58	4.2 3.8	900 1050	24.8 25.7	19.4 21.5	0.78 0.84	1.73 1.78	30.7 31.8	14.3 14.5	3.0 3.3
	8.0	3.7	8.5	900 1050	36.6 37.9	1.69 1.65	30.9 32.3	107.7 103.4	6.35 6.73	4.3 4.0	900 1050	25.8 26.0	19.7 21.7	0.76 0.83	1.71 1.74	31.6 31.9	15.1 14.9	2.8 3.1
100	4.0	1.6	3.6	Operation not recommended							Operation not recommended							
	6.0	2.4	5.6	Operation not recommended							Operation not recommended							
	8.0	3.5	8.2	Operation not recommended							Operation not recommended							
110	4.0	1.5	3.5	Operation not recommended							Operation not recommended							
	6.0	2.3	5.4	Operation not recommended							Operation not recommended							
	8.0	3.4	7.8	Operation not recommended							Operation not recommended							
120	4.0	1.5	3.4	Operation not recommended							Operation not recommended							
	6.0	2.2	5.2	Operation not recommended							Operation not recommended							
	8.0	3.3	7.5	Operation not recommended							Operation not recommended							

Performance Data

036 Water Heating Data

ELT	EST	LGPM	SOURCE 5.0 GPM					SWPD		HWC kBtu/h	SOURCE 7.0 GPM					SWPD		HWC kBtu/h	SOURCE 9.0 GPM					SWPD		HWC kBtu/h			
			LLT	HC	KW	HE	COP	LST	PSI		FT HD	LLT	HC	KW	HE	COP	LST		PSI	FT HD	LLT	HC	KW	HE	COP		LST	PSI	FT HD
80	30	5.0	Operation Not Recommended																										
		7.0	87.9	25.0	1.88	10.8	4.0	22.3	2.8	6.5	2.5	88.0	25.7	1.91	15.8	4.1	23.9	4.5	10.3	2.7	88.2	26.3	1.95	20.8	4.2	25.4	6.1	14.1	2.8
		9.0	85.7	25.2	1.86	19.6	4.1	22.2	2.8	6.5	2.4	85.9	25.9	1.90	20.4	4.2	23.8	4.5	10.3	2.5	86.0	26.6	1.94	21.1	4.3	25.3	6.1	14.1	2.6
80	40	5.0	Operation Not Recommended																										
		7.0	88.9	28.3	1.89	16.1	4.5	30.9	2.7	6.1	2.5	89.1	29.1	1.92	20.1	4.6	32.8	4.2	9.7	2.7	89.3	29.8	1.96	24.1	4.7	34.6	5.7	13.3	2.8
		9.0	86.4	28.5	1.87	22.8	4.6	30.8	2.7	6.1	2.4	86.6	29.2	1.91	23.6	4.7	32.7	4.2	9.7	2.5	86.8	30.0	1.95	24.4	4.8	34.5	5.7	13.2	2.6
80	50	5.0	92.7	31.7	1.93	17.1	4.9	39.6	2.5	5.8	2.7	93.0	32.4	1.96	22.1	5.0	41.8	4.0	9.1	2.8	93.3	33.1	1.99	27.2	5.1	44.0	5.4	12.5	2.9
		7.0	89.9	31.7	1.91	21.5	5.0	39.5	2.5	5.8	2.6	90.2	32.5	1.94	24.5	5.1	41.7	3.9	9.1	2.7	90.4	33.3	1.97	27.5	5.2	43.8	5.4	12.4	2.8
		9.0	87.2	31.7	1.88	26.0	5.1	39.4	2.5	5.8	2.5	87.4	32.6	1.92	26.9	5.2	41.6	3.9	9.1	2.5	87.6	33.5	1.95	27.8	5.3	43.7	5.4	12.4	2.6
80	60	5.0	94.1	35.1	1.95	24.7	5.3	48.1	2.4	5.4	2.7	94.4	35.8	1.98	27.6	5.4	50.7	3.7	8.5	2.8	94.7	36.6	2.01	30.5	5.5	53.2	5.1	11.7	2.9
		7.0	91.0	35.0	1.92	26.9	5.5	48.1	2.4	5.4	2.6	91.2	35.9	1.95	28.9	5.6	50.6	3.7	8.5	2.7	91.5	36.7	1.98	30.8	5.7	53.0	5.0	11.6	2.7
		9.0	87.9	35.0	1.89	29.1	5.6	48.0	2.4	5.4	2.5	88.1	35.9	1.92	30.1	5.7	50.5	3.7	8.5	2.5	88.3	36.9	1.96	31.1	5.9	52.9	5.0	11.5	2.6
80	70	5.0	95.4	38.5	1.97	32.3	5.8	56.7	2.2	5.1	2.7	95.8	39.3	2.00	33.1	5.9	59.6	3.5	8.0	2.8	96.1	40.1	2.03	33.9	6.0	62.4	4.7	10.9	2.8
		7.0	92.0	38.4	1.94	32.3	6.0	56.7	2.2	5.1	2.6	92.3	39.3	1.97	33.2	6.1	59.5	3.4	7.9	2.7	92.6	40.2	2.00	34.2	6.2	62.3	4.7	10.7	2.7
		9.0	88.6	38.2	1.90	32.3	6.1	56.6	2.2	5.1	2.5	88.9	39.3	1.93	33.4	6.2	59.4	3.4	7.9	2.6	89.1	40.3	1.96	34.4	6.4	62.1	4.6	10.6	2.6
100	30	5.0	Operation Not Recommended																										
		7.0	107.3	24.3	2.39	12.2	3.1	23.6	2.8	6.5	2.6	107.4	24.8	2.42	14.8	3.2	24.9	4.5	10.3	2.7	107.5	25.3	2.45	17.5	3.2	26.3	6.1	14.1	2.8
		9.0	105.3	24.2	2.37	16.5	3.2	23.6	2.8	6.5	2.5	105.4	24.8	2.41	17.1	3.2	24.9	4.5	10.3	2.5	105.5	25.4	2.44	17.6	3.3	26.2	6.1	14.1	2.6
100	40	5.0	Operation Not Recommended																										
		7.0	108.2	27.1	2.39	16.0	3.5	32.5	2.7	6.1	2.7	108.3	27.6	2.42	18.2	3.5	34.1	4.2	9.7	2.8	108.4	28.2	2.45	20.4	3.6	35.6	5.7	13.2	2.9
		9.0	105.9	27.0	2.37	19.2	3.5	32.5	2.7	6.1	2.6	106.0	27.6	2.40	19.8	3.6	34.0	4.2	9.7	2.7	106.1	28.2	2.44	20.4	3.7	35.6	5.7	13.2	2.7
100	50	5.0	111.5	30.0	2.43	17.7	3.7	41.4	2.5	5.8	3.0	111.7	30.6	2.46	20.4	3.8	43.2	3.9	9.1	3.1	111.9	31.2	2.49	23.2	3.8	45.1	5.4	12.4	3.2
		7.0	109.0	29.9	2.40	19.8	3.8	41.4	2.5	5.8	2.9	109.1	30.5	2.43	21.5	3.9	43.2	3.9	9.1	2.9	109.3	31.1	2.46	23.2	3.9	45.0	5.4	12.4	3.0
		9.0	106.5	29.8	2.37	21.9	3.9	41.4	2.5	5.8	2.7	106.6	30.5	2.40	22.6	3.9	43.2	3.9	9.1	2.8	106.7	31.1	2.43	23.3	4.0	44.9	5.4	12.4	2.9
100	60	5.0	112.6	32.8	2.44	22.6	4.1	50.3	2.4	5.4	3.1	112.8	33.4	2.47	24.4	4.1	52.3	3.7	8.5	3.2	113.0	34.1	2.50	26.1	4.2	54.4	5.0	11.6	3.3
		7.0	109.8	32.7	2.41	23.6	4.2	50.3	2.4	5.4	3.0	110.0	33.4	2.43	24.8	4.2	52.3	3.7	8.5	3.0	110.1	34.0	2.46	26.1	4.3	54.3	5.0	11.5	3.1
		9.0	107.0	32.6	2.37	24.6	4.2	50.3	2.4	5.4	2.8	107.1	33.3	2.40	25.3	4.3	52.3	3.7	8.5	2.9	107.3	34.0	2.43	26.1	4.4	54.3	5.0	11.5	3.0
100	70	5.0	113.7	35.7	2.46	27.5	4.4	59.2	2.2	5.1	3.2	113.9	36.3	2.48	28.3	4.5	61.5	3.4	7.9	3.3	114.2	37.0	2.51	29.1	4.5	63.8	4.7	10.7	3.4
		7.0	110.6	35.5	2.42	27.4	4.5	59.2	2.2	5.1	3.1	110.8	36.2	2.44	28.2	4.6	61.5	3.4	7.9	3.2	111.0	37.0	2.47	29.0	4.6	63.7	4.6	10.7	3.2
		9.0	107.6	35.4	2.38	27.3	4.6	59.3	2.2	5.1	3.0	107.7	36.1	2.40	28.1	4.7	61.4	3.4	7.9	3.0	107.9	36.9	2.42	28.9	4.7	63.6	4.6	10.6	3.1
120	30	5.0	Operation Not Recommended																										
		7.0	126.8	23.5	2.90	13.6	2.2	24.9	2.8	6.5	2.8	126.8	23.9	2.93	13.9	2.2	26.0	4.5	10.3	2.8	126.9	24.4	2.96	14.3	2.3	27.1	6.1	14.1	2.9
		9.0	124.9	23.2	2.88	13.4	2.2	25.0	2.8	6.5	2.5	124.9	23.7	2.91	13.8	2.3	26.1	4.5	10.3	2.6	124.9	24.1	2.94	14.1	2.3	27.1	6.1	14.1	2.6
120	40	5.0	Operation Not Recommended																										
		7.0	127.4	25.8	2.90	15.8	2.4	34.1	2.7	6.1	3.0	127.5	26.2	2.92	16.2	2.4	35.4	4.2	9.7	3.0	127.5	26.7	2.95	16.6	2.5	36.6	5.7	13.2	3.1
		9.0	125.3	25.5	2.87	15.6	2.4	34.2	2.7	6.1	2.7	125.3	26.0	2.90	16.0	2.5	35.4	4.2	9.7	2.8	125.3	26.5	2.93	16.4	2.5	36.6	5.7	13.2	2.9
120	50	5.0	130.3	28.3	2.93	18.2	2.6	43.2	2.5	5.8	3.4	130.4	28.8	2.96	18.8	2.6	44.7	3.9	9.1	3.4	130.5	29.3	2.98	19.3	2.6	46.2	5.4	12.4	3.5
		7.0	128.0	28.1	2.90	18.0	2.6	43.3	2.5	5.8	3.2	128.1	28.6	2.92	18.5	2.6	44.7	3.9	9.1	3.2	128.1	29.0	2.95	19.0	2.7	46.1	5.4	12.4	3.3
		9.0	125.8	27.9	2.87	17.9	2.7	43.5	2.5	5.8	3.0	125.8	28.3	2.89	18.3	2.7	44.8	3.9	9.1	3.0	125.8	28.8	2.91	18.8	2.7	46.1	5.4	12.4	3.1
120	60	5.0	131.1	30.6	2.94	20.5	2.8	52.4	2.4	5.4	3.5	131.2	31.1	2.96	21.1	2.8	54.0	3.7	8.5	3.6	131.4	31.6	2.99	21.8	2.8	55.7	5.0	11.5	3.7
		7.0	128.6	30.4	2.90	20.3	2.8	52.5	2.4	5.4	3.4	128.7	30.9	2.92	20.8	2.8	54.1	3.7	8.5	3.4	128.8	31.4	2.94	21.4	2.9	55.6	5.0	11.5	3.5
		9.0	126.2	30.2	2.86	20.1	2.9	52.7	2.4	5.4	3.2	126.2	30.7	2.88	20.6	2.9	54.1	3.7	8.5	3.3	126.2	31.2	2.90	21.1	2.9	55.6	5.0	11.5	3.4
120	70	5.0	131.9	32.8	2.94	22.7	3.0	61.6	2.2	5.1	3.7	132.1	33.4	2.97	23.5	3.0	63.4	3.4	7.9	3.8	132.2	33.9	2.99	24.2	3.0	65.2	4.6	10.6	3.9
		7.0	129.3	32.7	2.90	22.5	3.1	61.8	2.2	5.1	3.6	129.3	33.2	2.92	23.2	3.1	63.5	3.4	7.9	3.7	129.4	33.7	2.94	23.8	3.1	65.2	4.6	10.6	3.8
		9.0	126.6	32.5	2.85	22.3	3.1	61.9	2.2	5.1	3.4	126.6	33.0	2.87	22.9	3.1	63.5	3.4	7.9	3.5	126.6	33.5	2.88	23.4	3.1	65.1	4.6	10.6	3.6

*Water heating mode only allows high compressor capacity operation.

ELT = entering load fluid temperature to heat pump

LLT = leaving load fluid temperature from heat pump

LGPM = load flow in gallons per minute

LWPD = load coax water pressure drop

EST = entering source fluid temperature to heat pump

LST = leaving source fluid temperature from heat pump

HWC = desuperheater capacity

SWPD = source coax water pressure drop

PSI = pressure drop in pounds per square inch

FT HD = pressure drop in feet of head

KW = kilowatts

HE = heat extracted in BTUH

HC = total heating capacity in BTUH

COP = coefficient of performance [HC/(KW x 3.413)]

Performance Data

048 High Speed

EWT °F	Flow gpm	WPD		HEATING - EAT 70°F							COOLING - EAT 80/67 °F															
		PSI	FT	Airflow cfm	HC MBtu/h	Power kW	HE MBtu/h	LAT °F	COP	HWC MBtu/h	Airflow cfm	TC MBtu/h	SC MBtu/h	S/T Ratio	Power kW	HR MBtu/h	EER	HWC MBtu/h								
20	6.0	1.9	4.3	Operation not recommended							Operation not recommended															
	9.0	3.3	7.6	Operation not recommended							Operation not recommended															
	12.0	4.9	11.4	1350	33.3	2.92	23.4	92.8	3.35	4.7	1550	33.4	2.85	23.7	90.0	3.43	4.2									
30	6.0	1.8	4.2	Operation not recommended							Operation not recommended															
	9.0	3.2	7.4	1350	36.6	2.82	26.9	95.1	3.80	4.9	1550	37.6	2.91	27.7	92.5	3.79	4.5	1350	43.5	26.1	0.60	1.86	49.8	23.4	-	
	12.0	4.8	11.0	1350	38.3	3.01	28.0	96.3	3.73	5.0	1550	38.4	2.94	28.4	92.9	3.83	4.6	1350	43.7	26.1	0.60	1.80	49.9	24.3	-	
				1550	38.4	2.94	28.4	92.9	3.83	4.6	1550	44.8	28.5	0.64	1.89	51.2	23.7	-								
40	6.0	1.8	4.1	Operation not recommended							Operation not recommended															
	9.0	3.1	7.1	1350	41.8	2.94	31.8	98.7	4.17	5.6	1550	43.1	3.00	32.9	95.7	4.21	5.2	1350	47.8	30.4	0.64	2.01	54.6	23.8	-	
	12.0	4.6	10.7	1350	42.6	2.97	32.5	99.2	4.21	5.8	1550	44.0	3.03	33.7	96.3	4.26	5.3	1350	48.1	30.4	0.63	1.95	54.8	24.7	-	
				1550	44.0	3.03	33.7	96.3	4.26	5.3	1550	49.2	33.2	0.67	2.04	56.2	24.1	-								
50	6.0	1.7	3.9	1350	45.4	2.98	35.2	101.1	4.46	6.1	1550	46.7	3.02	36.4	97.9	4.53	5.6	1350	49.4	31.5	0.64	2.27	57.1	21.8	2.7	
	9.0	3.0	6.9	1350	47.0	3.05	36.6	102.3	4.52	6.3	1550	48.5	3.09	38.0	99.0	4.60	5.8	1350	50.4	31.9	0.63	2.14	57.7	23.6	2.5	
	12.0	4.5	10.4	1350	48.1	3.08	37.6	103.0	4.58	6.5	1550	49.6	3.12	39.0	99.6	4.66	5.9	1350	53.0	35.4	0.67	2.24	60.7	23.6	2.7	
				1550	49.6	3.12	39.0	99.6	4.66	5.9	1550	53.6	37.8	0.71	2.19	61.1	24.5	2.6								
60	6.0	1.7	3.8	1350	49.9	3.11	39.3	104.2	4.71	6.9	1550	51.5	3.13	40.8	100.8	4.83	6.4	1350	48.2	31.7	0.66	2.49	56.7	19.3	3.2	
	9.0	2.9	6.7	1350	52.1	3.19	41.2	105.8	4.78	7.1	1550	53.8	3.21	42.9	102.1	4.91	6.6	1350	49.3	32.0	0.65	2.37	57.4	20.8	3.0	
	12.0	4.3	10.0	1350	53.4	3.23	42.4	106.6	4.85	7.3	1550	55.2	3.24	44.1	102.9	4.99	6.7	1350	49.8	33.8	0.68	2.31	57.7	21.5	2.7	
				1550	55.2	3.24	44.1	102.9	4.99	6.7	1550	52.3	37.5	0.72	2.42	60.5	21.6	3.1								
70	6.0	1.6	3.7	1350	18.2	3.23	44.1	104.5	1.65	7.9	1550	18.2	3.27	45.0	103.6	1.65	7.3	1350	47.0	31.8	0.68	2.75	50.2	17.5	3.9	
	9.0	2.8	6.5	1350	57.2	3.33	45.9	109.3	5.03	8.1	1550	59.1	3.33	47.7	105.3	5.20	7.5	1350	48.2	32.2	0.67	2.60	57.1	18.5	3.7	
	12.0	4.2	9.7	1350	58.7	3.37	47.2	110.3	5.10	8.4	1550	60.7	3.36	49.2	106.3	5.29	7.7	1350	50.3	35.7	0.71	2.69	59.5	18.7	4.0	
				1550	60.7	3.36	49.2	106.3	5.29	7.7	1550	50.9	37.1	0.73	2.64	59.9	19.3	3.8								
80	6.0	1.5	3.6	1350	57.4	3.32	46.1	109.4	5.07	8.7	1550	59.4	3.29	48.2	105.5	5.29	8.1	1350	44.9	32.0	0.71	3.01	55.2	14.9	5.1	
	9.0	2.7	6.3	1350	60.7	3.45	48.9	111.6	5.15	9.0	1550	62.8	3.42	51.1	107.5	5.38	8.3	1350	46.1	32.4	0.70	2.91	56.1	15.9	4.7	
	12.0	4.1	9.4	1350	62.5	3.50	50.5	112.8	5.23	9.3	1550	64.6	3.45	52.8	108.6	5.50	8.6	1350	48.0	35.9	0.75	2.99	58.2	16.0	5.1	
				1550	64.6	3.45	52.8	108.6	5.50	8.6	1550	48.6	36.8	0.76	2.94	58.6	16.5	4.9								
90	6.0	1.5	3.4	1350	60.4	3.41	48.7	111.4	5.18	9.7	1550	62.5	3.36	51.1	107.4	5.45	9.0	1350	42.8	32.2	0.75	3.31	54.1	12.9	6.3	
	9.0	2.6	6.0	1350	64.2	3.57	52.0	114.0	5.27	10.0	1550	66.5	3.50	54.5	109.7	5.56	9.3	1350	44.1	32.7	0.74	3.22	55.0	13.7	5.9	
	12.0	3.9	9.0	1350	66.2	3.62	53.9	115.4	5.36	10.3	1550	68.5	3.53	56.5	110.9	5.69	9.6	1350	45.2	33.3	0.74	3.20	56.1	14.1	5.5	
				1550	68.5	3.53	56.5	110.9	5.69	9.6	1550	46.2	36.5	0.79	3.23	57.2	14.3	6.1								
100	6.0	1.4	3.3	Operation not recommended							Operation not recommended															
	9.0	2.5	5.8	Operation not recommended							Operation not recommended															
	12.0	3.8	8.7	1350	41.2	31.8	0.77	3.59	53.5	11.5	7.5	1550	42.6	35.3	0.83	3.65	55.0	11.7	8.1	1350	41.7	31.7	0.76	3.53	53.7	11.8
				1550	43.1	35.1	0.81	3.59	55.3	12.0	7.7	1550	43.1	35.1	0.81	3.59	55.3	12.0	7.7							
110	6.0	1.4	3.2	Operation not recommended							Operation not recommended															
	9.0	2.4	5.6	Operation not recommended							Operation not recommended															
	12.0	3.6	8.4	1350	38.5	30.9	0.80	3.97	52.0	9.7	9.3	1550	39.5	34.3	0.87	4.00	53.1	9.9	10.1	1350	38.8	30.4	0.78	3.90	52.1	10.0
				1550	39.9	33.6	0.84	3.94	53.3	10.1	9.6	1550	39.9	33.6	0.84	3.94	53.3	10.1	9.6							
120	6.0	1.3	3.1	Operation not recommended							Operation not recommended															
	9.0	2.3	5.4	Operation not recommended							Operation not recommended															
	12.0	3.5	8.1	1350	37.1	29.3	0.79	4.40	52.1	8.4	11.3	1550	37.7	31.8	0.84	4.51	53.1	8.4	12.2	1350	37.4	29.3	0.78	4.26	51.9	8.8
				1550	38.2	31.8	0.83	4.39	53.2	8.7	11.6	1550	38.2	31.8	0.83	4.39	53.2	8.7	11.6							

Performance Data

048 Low Speed

EWT °F	Flow gpm	WPD		HEATING - EAT 70°F							COOLING - EAT 80/67 °F							
		PSI	FT	Airflow cfm	HC MBtu/h	Power kW	HE MBtu/h	LAT °F	COP	HWC MBtu/h	Airflow cfm	TC MBtu/h	SC MBtu/h	S/T Ratio	Power kW	HR MBtu/h	EER	HWC MBtu/h
20	5.0	1.5	3.5	Operation not recommended							Operation not recommended							
	8.0	2.9	6.8	Operation not recommended							Operation not recommended							
	11.0	4.3	10.0	1150 1350	22.4 22.8	2.19 2.20	14.9 15.3	88.0 85.6	2.99 3.04	4.1 3.7								
30	5.0	1.5	3.4	Operation not recommended							Operation not recommended							
	8.0	2.8	6.6	1150 1350	24.0 25.0	2.09 2.15	16.9 17.7	89.3 87.1	3.36 3.41	4.2 3.8	1150 1350	32.9 33.5	18.8 20.5	0.57 0.61	1.13 1.19	36.8 37.5	29.2 28.1	- -
	11.0	4.2	9.7	1150 1350	26.1 26.6	2.19 2.20	18.6 19.1	91.0 88.2	3.49 3.54	4.3 3.9	1150 1350	33.1 33.9	18.8 20.5	0.57 0.60	1.10 1.15	36.8 37.8	30.2 29.5	- -
40	5.0	1.4	3.3	Operation not recommended							Operation not recommended							
	8.0	2.8	6.4	1150 1350	28.1 29.1	2.12 2.16	20.9 21.7	92.6 90.0	3.89 3.95	4.5 4.2	1150 1350	35.3 36.0	22.6 24.7	0.64 0.68	1.22 1.28	39.5 40.4	28.9 28.1	- -
	11.0	4.1	9.4	1150 1350	29.6 30.7	2.17 2.21	22.2 23.1	93.9 91.0	4.00 4.06	4.7 4.2	1150 1350	35.6 36.4	22.6 24.7	0.63 0.68	1.19 1.24	39.6 40.6	30.0 29.4	- -
50	5.0	1.4	3.2	1150 1350	31.1 32.1	2.14 2.17	23.8 24.7	95.0 92.0	4.25 4.33	4.8 4.4	1150 1350	36.9 37.9	25.2 27.9	0.68 0.74	1.35 1.00	41.5 41.3	27.3 37.9	1.6 1.7
	8.0	2.7	6.2	1150 1350	32.2 33.2	2.14 2.17	24.9 25.8	95.9 92.7	4.40 4.48	4.9 4.5	1150 1350	37.2 38.3	25.4 28.1	0.68 0.73	1.32 1.34	41.7 42.8	28.3 28.5	1.5 1.6
	11.0	3.9	9.1	1150 1350	33.7 34.7	2.19 2.22	26.2 27.1	97.1 93.8	4.50 4.58	5.1 4.6	1150 1350	37.8 38.9	26.0 28.8	0.69 0.74	1.30 1.33	42.3 43.4	29.0 29.2	1.4 1.5
60	5.0	1.3	3.1	1150 1350	34.8 35.7	2.16 2.18	27.4 28.2	98.0 94.5	4.72 4.81	5.2 4.8	1150 1350	35.6 36.6	25.2 27.9	0.71 0.76	1.53 1.56	40.8 41.9	23.3 23.5	2.3 2.4
	8.0	2.6	6.0	1150 1350	36.2 37.0	2.16 2.17	28.8 29.6	99.1 95.4	4.92 5.01	5.4 5.0	1150 1350	35.9 36.9	25.3 28.0	0.70 0.76	1.49 1.52	41.0 42.1	24.1 24.3	2.1 2.3
	11.0	3.8	8.8	1150 1350	37.5 38.3	2.20 2.22	29.9 30.7	100.2 96.3	4.98 5.07	5.5 5.1	1150 1350	36.5 37.6	26.0 28.8	0.71 0.77	1.48 1.51	41.6 42.7	24.7 25.0	1.9 2.2
70	5.0	1.3	3.0	1150 1350	38.5 39.1	2.18 2.20	31.0 31.6	101.0 96.8	5.18 5.21	5.8 5.4	1150 1350	34.3 35.6	25.1 28.5	0.73 0.80	1.71 1.88	40.2 41.4	20.1 18.9	3.0 3.1
	8.0	2.5	5.8	1150 1350	40.1 40.9	2.17 2.17	32.7 33.5	102.3 98.0	5.43 5.53	6.0 5.5	1150 1350	34.7 35.6	25.3 28.0	0.73 0.79	1.66 1.69	40.3 41.9	20.8 21.0	2.8 3.0
	11.0	3.7	8.5	1150 1350	41.2 41.9	2.21 2.21	33.6 34.4	103.2 98.7	5.45 5.56	6.1 5.7	1150 1350	35.2 36.2	25.9 28.7	0.74 0.79	1.65 1.68	40.8 42.0	21.4 21.5	2.6 2.8
80	5.0	1.3	2.9	1150 1350	41.9 42.4	2.17 2.16	34.5 35.1	103.7 99.1	5.66 5.77	6.5 6.0	1150 1350	32.6 33.5	24.8 27.4	0.76 0.82	1.98 2.01	39.3 40.4	16.5 16.6	4.2 4.4
	8.0	2.4	5.6	1150 1350	43.9 44.4	2.15 2.14	36.5 37.1	105.3 100.4	5.97 6.08	6.7 6.1	1150 1350	32.9 33.8	24.9 27.6	0.76 0.82	1.93 1.96	39.4 40.5	17.1 17.2	3.9 4.2
	11.0	3.6	8.2	1150 1350	44.5 45.0	2.20 2.18	37.0 37.5	105.8 100.8	5.93 6.04	6.9 6.3	1150 1350	33.4 34.4	25.6 28.3	0.77 0.82	1.91 1.95	39.9 41.0	17.5 17.7	3.6 4.0
90	5.0	1.2	2.8	1150 1350	45.2 45.6	2.16 2.13	37.9 38.3	106.4 101.3	6.14 6.26	7.2 6.7	1150 1350	30.8 31.7	24.4 27.0	0.79 0.85	2.25 2.29	38.5 39.5	13.7 13.8	5.4 5.7
	8.0	2.3	5.4	1150 1350	47.6 47.9	2.14 2.11	40.3 40.7	108.3 102.8	6.51 6.64	7.4 6.9	1150 1350	31.1 32.0	24.6 27.2	0.79 0.85	2.19 2.23	38.6 39.6	14.2 14.3	5.0 5.5
	11.0	3.4	7.9	1150 1350	47.8 48.0	2.18 2.15	40.3 40.7	108.5 102.9	6.41 6.54	7.7 7.1	1150 1350	32.2 32.5	25.6 27.9	0.80 0.86	2.16 2.21	39.6 40.0	14.9 14.7	4.7 5.2
100	5.0	1.2	2.7	Operation not recommended							Operation not recommended							
	8.0	2.2	5.2	1150 1350	29.1 29.9	2.39 2.65	0.82 0.89	2.50 2.55	37.6 38.6	11.6 11.7	3.6 3.9							
	11.0	3.3	7.6	1150 1350	29.5 30.4	2.45 2.72	0.83 0.89	2.48 2.53	38.0 39.0	11.9 12.0	3.3 3.7							
110	5.0	1.1	2.6	Operation not recommended							Operation not recommended							
	8.0	2.2	5.0	Operation not recommended							Operation not recommended							
	11.0	3.2	7.3	1150 1350	27.0 27.7	2.33 2.57	0.86 0.93	2.81 2.87	36.6 37.5	9.6 9.7	4.4 4.7							
120	5.0	1.1	2.5	Operation not recommended							Operation not recommended							
	8.0	2.1	4.8	1150 1350	24.4 24.8	2.29 2.49	0.94 1.00	3.24 3.32	35.4 36.1	7.5 7.5	5.3 5.7							
	11.0	3.1	7.1	1150 1350	24.6 25.1	2.29 2.49	0.93 0.99	3.13 3.23	35.3 36.1	7.8 7.8	4.9 5.4							

Performance Data

048 Water Heating Data

ELT	EST	LGPM	SOURCE 6.0 GPM						SWPD		HWC kBtu/h	SOURCE 9.0 GPM						SWPD		HWC kBtu/h	SOURCE 12.0 GPM						SWPD		HWC kBtu/h
			LLT	HC	KW	HE	COP	LST	PSI	FT HD		LLT	HC	KW	HE	COP	LST	PSI	FT HD		LLT	HC	KW	HE	COP	LST	PSI	FT HD	
80	30	6.0	Operation Not Recommended																										
		9.0	88.7	34.6	2.50	27.3	23.4	21.1	1.7	3.9	4.8	88.9	36.0	2.54	29.1	14.0	23.0	3.2	7.3	4.9	89.2	37.5	2.57	30.9	4.5	25.0	4.6	10.6	5.1
		12.0	85.6	34.7	2.47	27.6	42.8	21.0	1.7	3.9	4.6	85.9	36.2	2.51	29.5	23.7	23.1	3.2	7.3	4.8	86.2	37.7	2.54	31.4	4.6	25.1	4.6	10.6	4.9
80	40	6.0	Operation Not Recommended																										
		9.0	90.0	39.8	2.53	32.4	19.1	29.2	1.7	3.9	5.6	90.4	41.5	2.57	34.4	12.1	31.6	3.1	7.1	5.7	90.7	43.2	2.61	36.3	5.1	34.0	4.5	10.3	5.9
		12.0	86.6	40.0	2.49	32.8	33.8	29.1	1.7	3.9	5.4	86.9	41.8	2.53	34.9	19.5	31.6	3.1	7.1	5.6	87.2	43.6	2.57	37.0	5.3	34.1	4.5	10.3	5.7
80	50	6.0	95.2	44.7	2.61	37.0	5.0	37.5	1.7	3.8	6.7	95.7	46.6	2.65	39.0	5.2	40.3	3.0	6.9	6.7	96.3	48.5	2.70	41.0	5.4	43.1	4.4	10.0	6.8
		9.0	91.4	45.0	2.56	37.5	14.9	37.3	1.7	3.8	6.5	91.8	47.0	2.60	39.7	10.3	40.2	3.0	6.9	6.6	92.3	49.0	2.64	41.8	5.7	43.0	4.4	10.0	6.7
		12.0	87.6	45.3	2.52	38.1	24.7	37.2	1.7	3.8	6.3	87.9	47.4	2.55	40.3	15.3	40.1	3.0	6.9	6.4	88.3	49.5	2.59	42.6	5.9	43.0	4.4	10.0	6.5
80	60	6.0	96.9	49.8	2.65	42.1	5.5	45.7	1.6	3.8	7.5	97.6	51.9	2.70	44.2	5.7	48.9	2.9	6.8	7.6	98.3	54.1	2.74	46.4	5.9	52.1	4.2	9.8	7.6
		9.0	92.7	50.2	2.59	42.7	10.6	45.5	1.6	3.8	7.3	93.3	52.4	2.64	45.0	8.4	48.8	2.9	6.8	7.4	93.8	54.7	2.68	47.3	6.2	52.0	4.2	9.8	7.5
		12.0	88.6	50.6	2.54	43.3	15.7	45.2	1.6	3.8	7.1	88.9	53.0	2.58	45.7	11.1	48.6	2.9	6.8	7.2	89.3	55.3	2.62	48.2	6.6	52.0	4.2	9.8	7.3
80	70	6.0	98.6	54.9	2.69	47.1	6.0	53.9	1.6	3.7	8.4	99.5	57.3	2.74	49.4	6.2	57.6	2.9	6.6	8.4	100.3	59.7	2.79	51.7	6.5	61.2	4.1	9.5	8.4
		9.0	94.1	55.4	2.63	47.8	6.3	53.6	1.6	3.7	8.2	94.7	57.9	2.67	50.3	6.6	57.3	2.9	6.6	8.2	95.3	60.5	2.72	52.8	6.8	61.1	4.1	9.5	8.3
		12.0	89.6	55.9	2.56	48.5	6.6	53.3	1.6	3.7	7.9	90.0	58.6	2.60	51.2	6.9	57.1	2.9	6.6	8.0	90.3	61.2	2.64	53.8	7.2	60.9	4.1	9.5	8.1
100	30	6.0	Operation Not Recommended																										
		9.0	108.0	32.5	3.18	23.3	12.9	22.4	1.7	3.9	4.5	108.3	33.7	3.22	24.8	8.2	24.1	3.1	7.2	4.6	108.6	35.0	3.26	26.3	3.5	25.7	4.6	10.6	4.8
		12.0	105.4	32.6	3.14	23.6	22.6	22.4	1.7	3.9	4.4	105.6	33.8	3.18	25.2	13.1	24.1	3.2	7.3	4.5	105.9	35.1	3.22	26.7	3.6	25.8	4.6	10.6	4.6
100	40	6.0	Operation Not Recommended																										
		9.0	109.2	37.1	3.21	27.8	10.9	30.8	1.7	3.9	5.3	109.5	38.4	3.25	29.3	7.4	32.8	3.1	7.1	5.4	109.9	39.8	3.29	30.8	3.9	34.9	4.5	10.3	5.5
		12.0	106.2	37.3	3.17	28.3	18.2	30.7	1.7	3.9	5.1	106.5	38.7	3.20	29.9	11.1	32.8	3.1	7.1	5.2	106.7	40.2	3.24	31.5	4.1	34.9	4.5	10.3	5.3
100	50	6.0	113.8	41.3	3.29	31.8	3.9	39.4	1.7	3.8	6.2	114.2	42.6	3.33	33.1	4.0	41.8	3.0	6.9	6.3	114.6	43.9	3.37	34.5	4.2	44.2	4.3	10.0	6.4
		9.0	110.5	41.7	3.24	32.4	8.9	39.2	1.7	3.8	6.0	110.8	43.1	3.28	33.9	6.6	41.6	3.0	6.9	6.1	111.1	44.6	3.31	35.4	4.3	44.1	4.3	10.0	6.2
		12.0	107.1	42.1	3.19	33.0	13.9	39.0	1.7	3.8	5.8	107.3	43.6	3.23	34.7	9.2	41.5	3.0	6.9	5.9	107.6	45.2	3.26	36.4	4.5	44.0	4.4	10.0	6.1
100	60	6.0	115.4	45.8	3.33	36.2	4.3	47.8	1.6	3.8	7.0	115.8	47.2	3.36	37.5	4.4	50.6	2.9	6.7	7.0	116.2	48.5	3.40	38.9	4.5	53.5	4.2	9.7	7.1
		9.0	111.7	46.3	3.27	36.9	6.9	47.6	1.6	3.8	6.8	112.0	47.8	3.31	38.5	5.8	50.4	2.9	6.7	6.9	112.3	49.4	3.34	40.0	4.8	53.3	4.2	9.7	6.9
		12.0	107.9	46.8	3.22	37.6	9.5	47.3	1.6	3.8	6.6	108.2	48.5	3.25	39.4	7.3	50.2	2.9	6.8	6.7	108.5	50.3	3.28	41.2	5.0	53.1	4.2	9.8	6.8
100	70	6.0	117.0	50.3	3.37	40.6	4.7	56.3	1.6	3.7	7.8	117.4	51.7	3.40	41.9	4.8	59.5	2.9	6.6	7.8	117.8	53.1	3.43	43.2	4.9	62.7	4.1	9.5	7.8
		9.0	112.9	50.9	3.30	41.5	4.9	56.0	1.6	3.7	7.5	113.2	52.6	3.34	43.0	5.1	59.2	2.9	6.6	7.6	113.6	54.2	3.37	44.6	5.2	62.5	4.1	9.5	7.7
		12.0	108.8	51.6	3.24	42.3	5.1	55.6	1.6	3.7	7.3	109.1	53.5	3.27	44.2	5.3	58.9	2.9	6.6	7.4	109.4	55.4	3.31	46.1	5.5	62.2	4.1	9.5	7.5
120	30	6.0	Operation Not Recommended																										
		9.0	127.4	30.4	3.86	19.3	2.3	23.8	1.7	3.9	4.3	127.7	31.4	3.90	20.5	2.4	25.1	3.1	7.2	4.4	128.1	32.5	3.95	21.7	2.5	26.5	4.6	10.5	4.5
		12.0	125.1	30.4	3.81	19.6	2.4	23.7	1.7	3.9	4.1	125.3	31.5	3.86	20.8	2.5	25.1	3.2	7.3	4.2	125.5	32.5	3.90	22.0	2.5	26.4	4.6	10.6	4.3
120	40	6.0	Operation Not Recommended																										
		9.0	128.5	34.4	3.89	23.3	2.6	32.4	1.7	3.9	4.9	128.7	35.4	3.93	24.3	2.7	34.1	3.1	7.1	5.0	129.0	36.3	3.97	25.4	2.8	35.8	4.4	10.3	5.1
		12.0	125.8	34.6	3.84	23.7	2.7	32.3	1.7	3.9	4.8	126.0	35.7	3.88	24.9	2.8	34.0	3.1	7.1	4.9	126.2	36.8	3.92	26.1	2.8	35.7	4.5	10.3	5.0
120	50	6.0	132.5	38.0	3.97	26.6	2.8	41.3	1.7	3.8	5.8	132.7	38.7	4.00	27.3	2.9	43.3	3.0	6.9	5.9	132.9	39.4	4.04	28.0	2.9	45.4	4.3	9.9	6.0
		9.0	129.5	38.4	3.92	27.2	2.9	41.0	1.7	3.8	5.6	129.7	39.3	3.95	28.1	3.0	43.1	3.0	6.9	5.7	129.9	40.2	3.99	29.1	3.0	45.2	4.3	10.0	5.8
		12.0	126.6	38.8	3.87	27.9	3.0	40.8	1.7	3.8	5.4	126.8	39.9	3.90	29.0	3.1	42.9	3.0	6.9	5.5	127.0	41.0	3.94	30.2	3.2	45.0	4.4	10.0	5.6
120	60	6.0	133.9	41.9	4.01	30.3	3.1	50.0	1.6	3.8	6.4	134.0	42.4	4.03	30.8	3.1	52.4	2.9	6.7	6.5	134.1	42.9	4.05	31.4	3.2	54.8	4.2	9.7	6.6
		9.0	130.6	42.4	3.95	31.2	3.2	49.7	1.6	3.8	6.2	130.7	43.3	3.98	32.0	3.3	52.1	2.9	6.7	6.3	130.9	44.1	4.00	32.8	3.3	54.5	4.2	9.7	6.4
		12.0	127.3	43.0	3.89	32.0	3.3	49.4	1.6	3.8	6.1	127.5	44.1	3.92	33.1	3.4	51.8	2.9	6.8	6.2	127.7	45.3	3.95	34.2	3.5	54.2	4.2	9.8	6.3
120	70	6.0	135.3	45.7	4.04	34.1	3.3	58.7	1.6	3.7	7.1	135.3	46.1	4.06	34.4	3.4	61.5	2.9	6.6	7.2	135.2	46.4	4.07	34.7	3.4	64.2	4.1	9.5	7.2
		9.0	131.7	46.5	3.98	35.1	3.5	58.3	1.6	3.7	6.9	131.7	47.2	4.00	35.8	3.5	61.1	2.9	6.6	7.0	131.8	48.0	4.02	36.5	3.6	63.9	4.1	9.5	7.1
		12.0	128.0	47.2	3.92	36.1	3.6	57.9	1.6	3.7	6.7	128.2	48.4	3.95	37.2	3.7	60.7	2.9	6.6	6.8	128.4	49.5	3.97	38.3	3.8	63.5	4.1	9.5	6.9

*Water heating mode only allows high compressor capacity operation.

ELT = entering load fluid temperature to heat pump

LLT = leaving load fluid temperature from heat pump

LGPM = load flow in gallons per minute

LWPD = load coax water pressure drop

EST = entering source fluid temperature to heat pump

LST = leaving source fluid temperature from heat pump

HWC = desuperheater capacity

SWPD = source coax water pressure drop

PSI = pressure drop in pounds per square inch

FT HD = pressure drop in feet of head

KW = kilowatts

HE = heat extracted in BTUH

HC = total heating capacity in BTUH

COP = coefficient of performance [HC/(KW x 3.413)]

Performance Data

060 High Speed

EWT °F	Flow gpm	WPD		HEATING - EAT 70°F							COOLING - EAT 80/67 °F							
		PSI	FT	Airflow cfm	HC MBtu/h	Power kW	HE MBtu/h	LAT °F	COP	HWC MBtu/h	Airflow cfm	TC MBtu/h	SC MBtu/h	S/T Ratio	Power kW	HR MBtu/h	EER	HWC MBtu/h
20	8.0	2.3	5.4	Operation not recommended							Operation not recommended							
	12.0	4.9	11.4	Operation not recommended							Operation not recommended							
	16.0	7.5	17.3	1500 1800	42.0 42.8	3.74 3.70	29.3 30.2	95.9 92.0	3.29 3.39	5.7	Operation not recommended							
30	8.0	2.3	5.3	Operation not recommended							Operation not recommended							
	12.0	4.8	11.0	1500 1800	44.7 46.6	3.67 3.77	32.2 33.8	97.6 94.0	3.57 3.63	6.1 5.6	1500 1800	55.1 56.0	39.2 42.8	0.71 0.76	2.09 2.20	62.2 63.5	26.3 25.4	- -
	16.0	7.3	16.8	1500 1800	48.7 49.6	3.90 3.86	35.4 36.4	100.1 95.5	3.66 3.77	6.3 5.7	1500 1800	55.3 56.7	39.2 42.8	0.71 0.75	2.03 2.13	62.3 64.0	27.3 26.6	- -
40	8.0	2.2	5.1	Operation not recommended							Operation not recommended							
	12.0	4.6	10.7	1500 1800	52.2 54.0	3.86 3.93	39.0 40.5	102.2 97.8	3.96 4.02	6.6 6.3	1500 1800	62.5 63.7	41.6 45.4	0.67 0.71	2.48 2.60	71.0 72.5	25.2 24.5	- -
	16.0	7.1	16.3	1500 1800	55.0 56.9	3.95 4.03	41.5 43.1	103.9 99.2	4.08 4.14	7.1 6.5	1500 1800	63.0 64.4	41.6 45.4	0.66 0.70	2.40 2.52	71.2 73.0	26.2 25.6	- -
50	8.0	2.1	4.9	1500 1800	57.4 59.2	4.04 4.10	43.6 45.3	105.5 100.5	4.16 4.24	7.4 6.9	1500 1800	68.4 70.3	42.0 46.5	0.61 0.66	2.95 1.00	78.5 73.7	23.2 23.3	3.8 4.0
	12.0	4.5	10.4	1500 1800	59.5 61.3	4.05 4.10	45.7 47.3	106.7 101.5	4.31 4.38	7.7 7.1	1500 1800	69.0 70.9	42.3 46.8	0.61 0.66	2.87 2.93	78.8 80.9	24.0 24.2	3.6 3.9
	16.0	6.8	15.8	1500 1800	62.3 64.1	4.14 4.19	48.1 49.8	108.4 103.0	4.41 4.48	7.9 7.2	1500 1800	70.2 72.1	43.4 48.0	0.62 0.67	2.84 2.90	79.9 82.0	24.7 24.9	3.3 3.7
60	8.0	2.1	4.8	1500 1800	65.1 66.8	4.27 4.30	50.6 52.1	110.2 104.3	4.48 4.55	8.3 7.7	1500 1800	66.8 68.6	41.5 45.9	0.62 0.67	3.24 3.30	77.8 79.9	20.6 20.8	4.6 4.9
	12.0	4.3	10.0	1500 1800	67.8 69.4	4.26 4.28	53.2 54.7	111.8 105.7	4.66 4.75	8.6 7.9	1500 1800	67.4 69.3	41.7 46.2	0.62 0.67	3.15 3.21	78.1 80.2	21.4 21.6	4.3 4.7
	16.0	6.6	15.3	1500 1800	70.1 71.7	4.35 4.38	55.3 56.8	113.3 106.9	4.72 4.80	8.9 8.1	1500 1800	68.5 70.4	42.8 47.4	0.62 0.67	3.12 3.19	79.2 81.3	21.9 22.1	4.0 4.4
70	8.0	2.0	4.6	1500 1800	72.8 73.7	4.49 4.41	57.5 58.7	114.9 107.9	4.75 4.90	9.4 8.7	1500 1800	65.2 67.9	40.9 46.6	0.63 0.69	3.53 3.78	77.2 79.4	18.5 18.0	5.6 6.0
	12.0	4.2	9.7	1500 1800	76.0 77.4	4.47 4.47	60.7 62.1	116.9 109.8	4.98 5.07	9.7 9.9	1500 1800	65.8 67.6	41.1 45.5	0.63 0.67	3.43 3.50	77.5 80.1	19.3 19.3	5.3 5.7
	16.0	6.4	14.8	1500 1800	78.0 79.3	4.57 4.56	62.4 63.7	118.1 110.8	5.00 5.10	10.0 9.2	1500 1800	66.8 68.7	42.2 46.7	0.63 0.68	3.40 3.47	78.5 80.5	19.6 19.8	4.9 5.4
80	8.0	1.9	4.5	1500 1800	80.0 81.1	4.72 4.70	63.9 65.1	119.4 111.7	4.96 5.06	10.3 9.6	1500 1800	62.5 64.3	39.9 44.1	0.64 0.69	3.91 3.98	75.8 77.8	16.0 16.1	7.3 7.7
	12.0	4.1	9.4	1500 1800	83.8 84.8	4.70 4.66	67.8 68.9	121.8 113.6	5.23 5.33	10.7 9.9	1500 1800	63.1 64.8	40.1 44.4	0.64 0.68	3.81 3.88	76.1 78.1	16.6 16.7	6.8 7.4
	16.0	6.2	14.3	1500 1800	85.0 85.9	4.79 4.75	68.7 69.7	122.5 114.2	5.20 5.30	11.0 10.1	1500 1800	64.1 65.9	41.1 45.5	0.64 0.69	3.77 3.85	77.0 79.0	17.0 17.1	6.3 7.0
90	8.0	1.9	4.3	1500 1800	87.2 87.9	4.96 4.90	70.2 71.2	123.8 115.2	5.15 5.25	11.4 10.5	1500 1800	59.9 61.5	38.8 42.9	0.65 0.70	4.29 4.37	74.5 76.4	14.0 14.1	9.3 9.8
	12.0	3.9	9.0	1500 1800	91.7 92.3	4.92 4.85	74.9 75.7	126.6 117.5	5.46 5.57	11.7 10.9	1500 1800	60.4 62.1	39.0 43.2	0.65 0.70	4.18 4.26	74.7 76.6	14.5 14.6	8.6 9.4
	16.0	6.0	13.8	1500 1800	92.1 92.5	5.02 4.94	75.0 75.6	126.8 117.6	5.38 5.49	12.1 11.2	1500 1800	61.0 63.1	40.8 44.3	0.67 0.70	4.09 4.22	75.0 77.5	14.9 15.0	8.0 8.9
100	8.0	1.8	4.2	Operation not recommended							Operation not recommended							
	12.0	3.8	8.7	Operation not recommended							Operation not recommended							
	16.0	5.7	13.3	Operation not recommended							1500 1800	57.3 58.9	38.1 42.1	0.66 0.72	4.67 4.76	73.2 75.1	12.3 12.4	10.5 11.4
110	8.0	1.7	4.0	Operation not recommended							Operation not recommended							
	12.0	3.6	8.4	Operation not recommended							Operation not recommended							
	16.0	5.5	12.8	Operation not recommended							1500 1800	54.2 55.7	37.1 41.1	0.68 0.74	5.16 5.26	71.8 73.6	10.5 10.6	13.6 14.8
120	8.0	1.7	3.8	Operation not recommended							Operation not recommended							
	12.0	3.5	8.1	Operation not recommended							Operation not recommended							
	16.0	5.3	12.3	Operation not recommended							1500 1800	51.1 52.1	37.4 40.6	0.73 0.78	5.81 5.96	71.0 72.4	8.8 8.7	16.5 17.9
											1500 1800	51.6 52.7	37.4 40.6	0.72 0.77	5.62 5.80	70.8 72.5	9.2 9.1	15.3 17.0

Performance Data

060 Low Speed

EWT °F	Flow gpm	WPD		HEATING - EAT 70°F							COOLING - EAT 80/67 °F							
		PSI	FT	Airflow cfm	HC MBtu/h	Power kW	HE MBtu/h	LAT °F	COP	HWC MBtu/h	Airflow cfm	TC MBtu/h	SC MBtu/h	S/T Ratio	Power kW	HR MBtu/h	EER	HWC MBtu/h
20	6.0	1.6	3.8	Operation not recommended							Operation not recommended							
	10.0	3.7	8.7	Operation not recommended							Operation not recommended							
	14.0	6.0	13.8	1250 1500	25.6 26.2	2.78 2.76	16.1 16.8	89.0 86.2	2.70 2.78	4.6 4.2	Operation not recommended							
30	6.0	1.6	3.7	Operation not recommended							Operation not recommended							
	10.0	3.6	8.4	1250 1500	28.0 29.2	2.63 2.70	19.1 20.0	90.8 88.0	3.12 3.17	4.6 4.2	1250 1500	40.6 41.3	28.8 31.5	0.71 0.76	1.31 1.38	45.1 45.9	31.1 30.0	- -
	14.0	5.8	13.4	1250 1500	30.4 31.1	2.79 2.77	20.9 21.6	92.5 89.2	3.19 3.29	4.7 4.3	1250 1500	40.8 41.8	28.8 31.5	0.71 0.75	1.27 1.33	45.1 46.3	32.2 31.4	- -
40	6.0	1.5	3.6	Operation not recommended							Operation not recommended							
	10.0	3.5	8.2	1250 1500	34.0 35.2	2.69 2.74	24.8 25.8	95.2 91.7	3.71 3.76	5.1 4.6	1250 1500	46.4 47.3	31.8 34.8	0.69 0.74	1.46 1.53	51.4 52.5	31.7 30.8	- -
	14.0	5.6	13.0	1250 1500	35.8 37.1	2.75 2.81	26.4 27.5	96.5 92.9	3.81 3.87	5.2 4.8	1250 1500	46.8 47.8	31.8 34.8	0.68 0.73	1.42 1.49	51.6 52.9	32.9 32.2	- -
50	6.0	1.5	3.5	1250 1500	38.5 39.7	2.74 2.78	29.2 30.3	98.5 94.5	4.12 4.19	5.3 4.9	1250 1500	51.0 52.5	33.3 36.8	0.65 0.70	1.67 1.00	56.7 55.9	30.6 32.5	1.9 2.0
	10.0	3.4	7.9	1250 1500	39.9 41.1	2.74 2.78	30.5 31.6	99.6 95.4	4.26 4.34	5.5 5.1	1250 1500	51.5 52.9	33.5 37.1	0.65 0.70	1.62 1.65	57.0 58.6	31.7 32.0	1.8 1.9
	14.0	5.4	12.6	1250 1500	41.8 43.0	2.81 2.84	32.2 33.3	100.9 96.5	4.36 4.44	5.7 5.2	1250 1500	52.3 53.8	34.3 38.0	0.66 0.71	1.61 1.64	57.8 59.4	32.5 32.8	1.6 1.8
60	6.0	1.4	3.3	1250 1500	44.4 45.5	2.81 2.83	34.8 35.8	102.9 98.1	4.63 4.71	6.0 5.5	1250 1500	48.7 50.1	32.5 36.0	0.67 0.72	1.95 1.98	55.4 56.8	25.0 25.2	2.6 2.8
	10.0	3.3	7.6	1250 1500	46.2 47.2	2.81 2.82	36.6 37.6	104.2 99.2	4.82 4.90	6.1 5.7	1250 1500	49.2 50.5	32.7 36.2	0.66 0.72	1.90 1.93	55.6 57.1	25.9 26.1	2.5 2.7
	14.0	5.3	12.2	1250 1500	47.8 48.9	2.87 2.89	38.0 39.0	105.4 100.2	4.88 4.96	6.3 5.8	1250 1500	50.0 51.4	33.5 37.1	0.67 0.72	1.88 1.92	56.4 57.9	26.6 26.8	2.3 2.5
70	6.0	1.4	3.2	1250 1500	50.2 50.5	2.88 2.91	40.4 40.6	107.2 101.2	5.10 5.09	6.7 6.2	1250 1500	46.4 47.6	31.7 35.8	0.68 0.75	2.22 2.52	54.0 55.6	20.9 18.9	3.7 3.9
	10.0	3.2	7.4	1250 1500	52.4 53.4	2.87 2.87	42.6 43.6	108.8 102.9	5.35 5.45	7.0 6.4	1250 1500	46.8 48.1	31.9 35.3	0.68 0.73	2.17 2.21	54.2 56.2	21.6 21.8	3.4 3.7
	14.0	5.1	11.8	1250 1500	53.8 54.7	2.94 2.93	43.8 44.7	109.8 103.8	5.37 5.47	7.2 6.6	1250 1500	47.6 48.9	32.7 36.2	0.69 0.74	2.15 2.19	54.9 56.4	22.1 22.3	3.2 3.5
80	6.0	1.4	3.1	1250 1500	56.3 57.1	2.96 2.94	46.2 47.1	111.7 105.3	5.58 5.69	7.4 6.9	1250 1500	44.0 45.2	30.8 34.1	0.70 0.76	2.58 2.63	52.8 54.2	17.0 17.2	5.1 5.4
	10.0	3.1	7.1	1250 1500	59.1 59.7	2.94 2.92	49.0 49.8	113.7 106.9	5.89 6.00	7.7 7.1	1250 1500	44.4 45.6	31.0 34.3	0.70 0.75	2.51 2.56	52.9 54.3	17.6 17.8	4.8 5.2
	14.0	4.9	11.4	1250 1500	59.9 60.5	3.00 2.98	49.6 50.3	114.4 107.3	5.85 5.96	7.9 7.3	1250 1500	45.1 46.4	31.8 35.2	0.71 0.76	2.49 2.54	53.6 55.0	18.1 18.2	4.4 4.9
90	6.0	1.3	3.0	1250 1500	62.5 63.0	3.03 3.00	52.1 52.8	116.3 108.9	6.04 6.16	8.3 7.7	1250 1500	41.6 42.7	30.0 33.2	0.72 0.78	2.94 2.99	51.6 52.9	14.2 14.3	6.8 7.2
	10.0	3.0	6.9	1250 1500	65.7 66.1	3.01 2.97	55.4 56.0	118.7 110.8	6.40 6.53	8.6 7.9	1250 1500	41.9 43.1	30.1 33.3	0.72 0.77	2.86 2.92	51.7 53.0	14.7 14.8	6.4 6.9
	14.0	4.8	11.0	1250 1500	66.0 66.3	3.07 3.02	55.5 56.0	118.9 110.9	6.30 6.43	8.8 8.2	1250 1500	42.5 43.8	30.8 34.2	0.72 0.78	2.83 2.89	52.2 53.7	15.0 15.2	5.9 6.6
100	6.0	1.3	2.9	Operation not recommended							Operation not recommended							
	10.0	2.9	6.6	Operation not recommended							Operation not recommended							
	14.0	4.6	10.6	1250 1500	38.1 39.2	28.9 31.9	0.76 0.81	3.28 3.34	49.3 50.6	11.6 11.7	8.3 8.9	1250 1500	38.8 39.9	29.6 32.8	0.76 0.82	3.25 3.32	49.9 51.2	11.9 12.0
110	6.0	1.2	2.8	Operation not recommended							Operation not recommended							
	10.0	2.8	6.4	Operation not recommended							Operation not recommended							
	14.0	4.4	10.2	1250 1500	34.4 35.3	27.6 30.5	0.80 0.86	3.70 3.77	47.0 48.2	9.3 9.4	10.4 11.3	1250 1500	34.9 35.9	28.3 31.3	0.81 0.87	3.67 3.74	47.4 48.7	9.5 9.6
120	6.0	1.2	2.7	Operation not recommended							Operation not recommended							
	10.0	2.7	6.1	Operation not recommended							Operation not recommended							
	14.0	4.2	9.8	1250 1500	30.9 31.4	27.0 29.3	0.87 0.93	4.22 4.33	45.3 46.2	7.3 7.3	12.6 13.6	1250 1500	31.1 31.8	27.0 29.3	0.87 0.92	4.08 4.21	45.1 46.2	7.6 7.6

Performance Data

060 Water Heating Data

ELT	EST	LGPM	SOURCE 8.0 GPM							SWPD		HWC	SOURCE 12.0 GPM							SWPD		HWC	SOURCE 16.0 GPM							SWPD		HWC
			LLT	HC	KW	HE	COP	LST	PSI	FT HD	kBtuh	LLT	HC	KW	HE	COP	LST	PSI	FT HD	kBtuh	LLT	HC	KW	HE	COP	LST	PSI	FT HD	kBtuh			
80	30	8.0	Operation Not Recommended																													
		12.0	88.8	45.8	3.26	35.5	23.0	21.0	2.3	5.2	5.7	88.5	45.9	3.34	37.1	13.7	23.0	4.7	10.8	5.8	88.2	46.0	3.42	38.6	4.5	25.1	7.1	16.4	5.9			
		16.0	85.8	45.8	3.24	35.8	4.4	20.9	2.3	5.2	5.5	86.0	45.9	3.32	37.3	4.5	23.0	4.7	10.8	5.6	86.2	46.0	3.39	38.8	4.7	25.1	7.1	16.4	5.7			
80	40	8.0	Operation Not Recommended																													
		12.0	90.1	52.3	3.30	42.4	26.5	29.2	2.2	5.1	6.6	90.1	53.5	3.38	44.4	15.8	31.6	4.6	10.6	6.7	90.0	54.6	3.46	46.4	5.2	34.1	7.0	16.1	6.8			
		16.0	86.7	52.5	3.27	42.8	20.4	29.1	2.2	5.1	6.3	87.0	53.6	3.35	44.7	12.9	31.6	4.6	10.6	6.5	87.3	54.7	3.42	46.7	5.4	34.1	7.0	16.1	6.6			
80	50	8.0	95.3	58.6	3.39	49.0	23.9	37.5	2.2	5.0	7.7	95.3	60.9	3.48	51.4	14.7	40.3	4.5	10.4	7.9	95.4	63.2	3.57	53.9	5.5	43.1	6.8	15.7	8.0			
		12.0	91.5	58.9	3.35	49.4	30.1	37.4	2.2	5.0	7.4	91.6	61.1	3.43	51.8	17.9	40.2	4.5	10.4	7.6	91.8	63.3	3.51	54.2	5.8	43.1	6.8	15.7	7.7			
		16.0	87.7	59.2	3.30	49.8	36.4	37.3	2.2	5.0	7.2	88.0	61.3	3.38	52.2	21.2	40.2	4.5	10.4	7.3	88.3	63.4	3.46	54.6	6.0	43.0	6.8	15.7	7.5			
80	60	8.0	97.0	65.1	3.45	55.9	15.0	45.7	2.1	4.9	8.6	97.5	68.4	3.54	58.7	10.6	48.9	4.4	10.2	8.8	97.9	71.8	3.64	61.6	6.1	52.1	6.7	15.4	9.0			
		12.0	92.8	65.5	3.39	56.3	33.7	45.6	2.1	4.9	8.3	93.2	68.7	3.48	59.2	20.0	48.8	4.4	10.2	8.5	93.6	71.9	3.56	62.0	6.4	52.0	6.7	15.4	8.6			
		16.0	88.6	65.9	3.33	56.7	52.3	45.5	2.1	4.9	8.0	89.0	69.0	3.41	59.6	29.5	48.7	4.4	10.1	8.2	89.4	72.0	3.49	62.4	6.7	52.0	6.7	15.4	8.3			
80	70	8.0	98.8	71.5	3.51	62.8	6.2	53.9	2.1	4.9	9.5	99.7	76.0	3.61	66.1	6.5	57.5	4.3	9.9	9.7	100.5	80.4	3.70	69.3	6.7	61.1	6.5	15.0	9.9			
		12.0	94.2	72.1	3.44	63.3	37.3	53.8	2.1	4.9	9.2	94.8	76.3	3.52	66.5	22.1	57.4	4.3	9.9	9.4	95.5	80.6	3.61	69.8	7.0	61.0	6.5	15.0	9.6			
		16.0	89.5	72.6	3.36	63.7	68.3	53.7	2.1	4.9	8.8	90.0	76.7	3.44	67.0	37.8	57.3	4.3	9.9	9.0	90.4	80.7	3.52	70.3	7.4	60.9	6.5	15.0	9.2			
100	30	8.0	Operation Not Recommended																													
		12.0	108.5	44.4	4.38	31.2	12.7	22.1	2.3	5.3	5.6	108.4	45.0	4.38	32.5	8.1	23.9	4.7	10.8	5.6	108.4	45.6	4.38	33.8	3.6	25.7	7.1	16.4	5.7			
		16.0	105.7	44.6	4.20	31.5	3.5	22.1	2.3	5.3	5.4	105.9	45.1	4.27	32.8	3.6	23.9	4.7	10.8	5.4	106.0	45.7	4.34	34.1	3.7	25.7	7.1	16.4	5.5			
100	40	8.0	Operation Not Recommended																													
		12.0	109.8	50.5	4.38	37.8	14.7	30.4	2.2	5.2	6.4	109.9	51.9	4.41	39.4	9.4	32.6	4.6	10.6	6.4	110.0	53.3	4.43	41.1	4.1	34.8	7.0	16.1	6.5			
		16.0	106.6	50.7	4.23	38.1	11.6	30.3	2.2	5.2	6.1	106.8	52.0	4.30	39.7	7.9	32.5	4.6	10.6	6.2	107.0	53.4	4.37	41.4	4.2	34.7	7.0	16.1	6.3			
100	50	8.0	114.7	56.5	4.53	44.0	13.5	38.8	2.2	5.1	7.5	114.9	58.7	4.54	46.0	8.9	41.3	4.5	10.4	7.5	115.2	61.0	4.55	48.0	4.4	43.9	6.8	15.7	7.6			
		12.0	111.1	56.6	4.39	44.3	16.6	38.7	2.2	5.1	7.2	111.3	58.8	4.43	46.3	10.6	41.2	4.5	10.4	7.2	111.6	61.0	4.48	48.3	4.5	43.8	6.8	15.7	7.3			
		16.0	107.4	56.8	4.25	44.7	19.8	38.6	2.2	5.1	6.9	107.7	58.9	4.33	46.7	12.3	41.2	4.5	10.4	7.0	107.9	61.1	4.40	48.7	4.7	43.8	6.8	15.7	7.1			
100	60	8.0	116.4	62.6	4.52	50.5	9.2	47.1	2.1	5.0	8.3	116.9	65.6	4.57	52.8	7.0	50.0	4.4	10.2	8.4	117.4	68.7	4.62	55.2	4.8	52.9	6.7	15.4	8.4			
		12.0	112.4	62.7	4.40	50.9	18.6	47.0	2.1	5.0	8.0	112.7	65.7	4.46	53.2	11.8	49.9	4.4	10.2	8.0	113.1	68.7	4.52	55.6	5.0	52.9	6.7	15.4	8.1			
		16.0	108.3	62.9	4.28	51.3	28.0	46.9	2.1	5.0	7.6	108.6	65.9	4.35	53.6	16.6	49.8	4.4	10.2	7.7	108.9	68.8	4.43	56.0	5.2	52.8	6.7	15.4	7.9			
100	70	8.0	118.2	68.7	4.51	57.0	4.9	55.4	2.1	4.9	9.2	118.9	72.5	4.60	59.7	5.1	58.7	4.3	9.9	9.2	119.6	76.4	4.69	62.4	5.3	62.0	6.5	15.0	9.3			
		12.0	113.7	68.9	4.41	57.5	20.5	55.3	2.1	4.9	8.8	114.2	72.7	4.49	60.1	13.0	58.6	4.3	9.9	8.9	114.7	76.5	4.57	62.8	5.5	61.9	6.5	15.0	9.0			
		16.0	109.2	69.0	4.31	57.9	36.1	55.2	2.1	4.9	8.4	109.5	72.8	4.38	60.6	20.9	58.5	4.3	9.9	8.5	109.9	76.6	4.46	63.3	5.8	61.8	6.5	15.0	8.7			
120	30	8.0	Operation Not Recommended																													
		12.0	128.2	43.1	5.50	27.0	2.5	23.3	2.3	5.3	5.4	128.4	44.1	5.42	28.0	2.5	24.8	4.7	10.9	5.5	128.6	45.2	5.35	29.1	2.6	26.4	7.1	16.4	5.5			
		16.0	125.6	43.3	5.16	27.2	2.5	23.2	2.3	5.3	5.2	125.7	44.3	5.23	28.3	2.6	24.8	4.7	10.9	5.3	125.8	45.3	5.29	29.3	2.7	26.3	7.1	16.4	5.3			
120	40	8.0	Operation Not Recommended																													
		12.0	129.4	48.7	5.47	33.1	2.8	31.6	2.3	5.2	6.1	129.7	50.3	5.43	34.4	2.9	33.5	4.6	10.6	6.2	129.9	52.0	5.39	35.8	3.0	35.5	7.0	16.1	6.2			
		16.0	126.4	48.8	5.18	33.4	2.9	31.6	2.3	5.2	5.9	126.5	50.5	5.25	34.7	3.0	33.5	4.6	10.6	5.9	126.7	52.1	5.32	36.1	3.0	35.4	7.0	16.1	6.0			
120	50	8.0	134.2	54.4	5.67	39.0	3.0	40.1	2.2	5.1	7.2	134.6	56.5	5.60	40.5	3.1	42.4	4.5	10.4	7.2	135.0	58.7	5.54	42.1	3.2	44.7	6.8	15.7	7.2			
		12.0	130.7	54.4	5.44	39.3	3.1	40.0	2.2	5.1	6.9	131.0	56.6	5.44	40.9	3.2	42.3	4.5	10.4	6.9	131.3	58.8	5.44	42.5	3.3	44.6	6.8	15.7	6.9			
		16.0	127.2	54.4	5.21	39.7	3.2	39.9	2.2	5.1	6.6	127.4	56.6	5.27	41.2	3.3	42.2	4.5	10.4	6.6	127.6	58.9	5.34	42.8	3.4	44.5	6.8	15.7	6.7			
120	60	8.0	135.8	60.1	5.59	45.1	3.3	48.4	2.2	5.0	8.0	136.3	62.8	5.60	46.9	3.4	51.1	4.4	10.2	7.9	136.8	65.5	5.60	48.8	3.5	53.8	6.7	15.4	7.9			
		12.0	131.9	60.0	5.41	45.5	3.5	48.3	2.2	5.0	7.6	132.3	62.8	5.45	47.3	3.6	51.0	4.4	10.2	7.6	132.6	65.6	5.48	49.2	3.7	53.7	6.7	15.4	7.6			
		16.0	128.0	59.9	5.23	45.9	3.6	48.3	2.2	5.0	7.2	128.2	62.8	5.30	47.7	3.7	50.9	4.4	10.2	7.3	128.4	65.6	5.37	49.6	3.8	53.6	6.7	15.4	7.4			
120	70	8.0	137.5	65.9	5.51	51.2	3.7	56.8	2.1	4.9	8.8	138.1	69.1	5.59	53.3	3.8	59.9	4.3	9.9	8.7	138.6	72.3	5.67	55.4	3.9	62.9	6.5	15.0	8.6			
		12.0	133.2	65.7	5.38	51.7	3.8	56.7	2.1	4.9	8.4	133.6	69.0	5.46	53.8	3.9	59.8	4.3	9.9	8.4	134.0	72.4	5.53	55.9	4.0	62.8	6.5	15.0	8.4			
		16.0	128.8	65.4	5.25	52.1	3.9	56.6	2.1	4.9	7.9	129.1	68.9	5.32	54.2	4.0	59.7	4.3	9.9	8.0	129.3	72.4	5.39	56.3	4.2	62.7	6.5	15.0	8.1			

*Water heating mode only allows high compressor capacity operation.

ELT = entering load fluid temperature to heat pump

LLT = leaving load fluid temperature from heat pump

LGPM = load flow in gallons per minute

LWPD = load coax water pressure drop

EST = entering source fluid temperature to heat pump

LST = leaving source fluid temperature from heat pump

HWC = desuperheater capacity

SWPD = source coax water pressure drop

PSI = pressure drop in pounds per square inch

FT HD = pressure drop in feet of head

KW = kilowatts

HE = heat extracted in BTUH

HC = total heating capacity in BTUH

COP = coefficient of performance $[HC/(KW \times 3.413)]$

Performance Data

072 High Speed

EWT °F	Flow gpm	WPD		HEATING - EAT 70°F							COOLING - EAT 80/67 °F							
		PSI	FT	Airflow cfm	HC MBtu/h	Power kW	HE MBtu/h	LAT °F	COP	HWC MBtu/h	Airflow cfm	TC MBtu/h	SC MBtu/h	S/T Ratio	Power kW	HR MBtu/h	EER	HWC MBtu/h
20	12.0	4.7	10.8	Operation not recommended							Operation not recommended							
	15.0	7.3	16.8	Operation not recommended							Operation not recommended							
	18.0	9.7	22.4	1850 2200	50.5 51.6	4.45 4.50	35.3 36.2	95.3 91.7	3.32 3.36	7.9 7.1								
30	12.0	4.5	10.5	Operation not recommended							Operation not recommended							
	15.0	7.0	16.3	1850 2200	56.4 58.0	4.50 4.63	41.1 42.2	98.2 94.4	3.68 3.67	8.3 7.6	1850 2200	72.0 73.1	49.6 54.2	0.69 0.74	3.01 3.18	82.3 84.0	23.9 23.0	- -
	18.0	9.4	21.8	1850 2200	57.9 59.2	4.63 4.68	42.1 43.2	99.0 94.9	3.67 3.71	8.5 7.7	1850 2200	72.3 74.1	49.6 54.2	0.69 0.73	2.92 3.07	82.3 84.6	24.7 24.1	- -
40	12.0	4.4	10.2	Operation not recommended							Operation not recommended							
	15.0	6.8	15.8	1850 2200	64.5 66.5	4.72 4.82	48.4 50.0	102.3 98.0	4.00 4.04	9.2 8.4	1850 2200	75.7 77.1	51.4 56.1	0.68 0.73	3.31 3.47	87.0 88.9	22.9 22.2	- -
	18.0	9.1	21.1	1850 2200	65.8 67.9	4.76 4.87	49.5 51.3	102.9 98.6	4.05 4.09	9.5 8.6	1850 2200	76.2 78.0	51.4 56.1	0.67 0.72	3.21 3.36	87.2 89.4	23.7 23.2	- -
50	12.0	4.3	9.9	1850 2200	70.0 72.1	4.83 4.89	53.5 55.4	105.0 100.3	4.25 4.32	9.9 9.2	1850 2200	75.3 79.3	48.3 53.7	0.64 0.68	3.78 3.98	88.2 92.9	19.9 19.9	4.3 4.5
	15.0	6.6	15.3	1850 2200	72.5 74.9	4.94 5.01	55.7 57.8	106.3 101.5	4.30 4.38	10.2 9.4	1850 2200	76.9 80.9	48.9 54.3	0.64 0.67	3.56 3.74	89.1 93.7	21.6 21.6	4.0 4.3
	18.0	8.9	20.5	1850 2200	74.2 76.5	4.98 5.05	57.2 59.3	107.1 102.2	4.36 4.44	10.5 9.6	1850 2200	77.7 81.8	52.2 58.0	0.67 0.71	3.48 3.65	89.5 94.3	22.3 22.4	3.7 4.1
60	12.0	4.1	9.6	1850 2200	78.0 80.5	5.06 5.10	60.7 63.1	109.0 103.9	4.51 4.63	11.1 10.3	1850 2200	74.1 77.7	48.8 54.3	0.66 0.70	4.10 4.28	88.1 92.3	18.1 18.1	5.5 5.5
	15.0	6.4	14.8	1850 2200	81.5 84.1	5.21 5.24	63.7 66.2	110.8 105.4	4.58 4.70	11.5 10.6	1850 2200	75.8 79.4	49.4 54.8	0.65 0.69	3.90 4.06	89.1 93.3	19.5 19.6	4.9 5.3
	18.0	8.6	19.8	1850 2200	83.5 86.2	5.26 5.29	65.5 68.2	111.8 106.3	4.65 4.78	11.8 10.9	1850 2200	76.6 80.4	52.1 57.8	0.68 0.72	3.80 3.97	89.5 93.9	20.2 20.2	4.5 5.0
70	12.0	4.0	9.2	1850 2200	18.2 92.1	5.30 5.42	72.2 73.6	110.6 108.8	1.01 4.98	12.5 11.6	1850 2200	72.9 78.7	49.3 56.9	0.68 0.72	4.35 4.47	76.1 92.9	17.5 17.6	6.6 6.9
	15.0	6.2	14.3	1850 2200	90.4 93.4	5.48 5.48	71.7 74.7	115.3 109.3	4.84 5.00	12.9 11.9	1850 2200	74.7 78.0	49.9 55.3	0.67 0.71	4.23 4.37	89.2 93.5	17.7 17.8	6.1 6.6
	18.0	8.3	19.2	1850 2200	92.7 95.9	5.54 5.52	73.8 77.1	116.4 110.4	4.90 5.09	13.3 12.3	1850 2200	75.5 78.9	51.9 57.5	0.69 0.73	4.12 4.29	89.6 94.0	18.3 18.4	5.7 6.3
80	12.0	3.9	8.9	1850 2200	93.4 96.7	5.59 5.55	74.4 77.8	116.8 110.7	4.90 5.11	13.9 12.8	1850 2200	70.3 73.1	48.6 54.0	0.69 0.74	4.86 5.01	86.9 90.2	14.5 14.6	8.4 8.9
	15.0	6.0	13.8	1850 2200	98.8 102.2	5.81 5.76	79.0 82.6	119.5 113.0	4.98 5.20	14.3 13.2	1850 2200	72.2 75.1	49.2 54.5	0.68 0.73	4.69 4.83	88.2 91.6	15.4 15.6	7.8 8.4
	18.0	8.0	18.5	1850 2200	101.7 105.2	5.89 5.80	81.6 85.4	120.9 114.3	5.06 5.31	14.7 13.6	1850 2200	73.0 76.0	50.4 55.9	0.69 0.73	4.59 4.73	88.7 92.1	15.9 16.1	7.2 8.0
90	12.0	3.7	8.6	1850 2200	100.9 104.5	5.88 5.79	80.8 84.7	120.5 114.0	5.03 5.29	15.4 14.3	1850 2200	67.7 70.1	47.9 53.2	0.71 0.76	5.30 5.43	85.8 88.6	12.8 12.9	10.5 11.1
	15.0	5.8	13.3	1850 2200	107.2 111.0	6.15 6.04	86.2 90.4	123.7 116.7	5.11 5.39	15.9 14.7	1850 2200	69.7 72.3	48.5 53.8	0.70 0.74	5.15 5.28	87.3 90.3	13.5 13.7	9.8 10.6
	18.0	7.7	17.9	1850 2200	110.6 114.4	6.23 6.08	89.3 93.7	125.4 118.1	5.20 5.51	16.4 15.2	1850 2200	71.7 73.1	50.1 54.2	0.70 0.74	4.93 5.17	88.5 90.7	14.5 14.1	9.1 10.1
100	12.0	3.6	8.3	Operation not recommended							Operation not recommended							
	15.0	5.6	12.9	1850 2200	66.2 68.3	4.78 5.31	0.72 0.78	5.79 5.88	85.9 88.4	11.4 11.6	12.2 13.2							
	18.0	7.5	17.2	1850 2200	66.9 69.1	4.77 5.28	0.71 0.76	5.69 5.78	86.3 88.8	11.8 12.0	11.3 12.5							
110	12.0	3.5	8.0	Operation not recommended							Operation not recommended							
	15.0	5.4	12.4	1850 2200	62.6 64.4	4.72 5.24	0.75 0.81	6.43 6.47	84.6 86.4	9.7 9.9	14.9 16.1							
	18.0	7.2	16.6	1850 2200	63.3 65.0	4.66 5.14	0.74 0.79	6.31 6.38	84.8 86.8	10.0 10.2	13.8 15.3							
120	12.0	3.3	7.7	Operation not recommended							Operation not recommended							
	15.0	5.1	11.9	1850 2200	59.1 60.2	4.59 4.98	0.78 0.83	7.10 7.29	83.3 85.0	8.3 8.3	18.0 19.5							
	18.0	6.9	15.9	1850 2200	59.6 60.9	4.59 4.98	0.77 0.82	6.87 7.09	83.1 85.1	8.7 8.6	16.7 18.5							

Performance Data

072 Low Speed

EWT °F	Flow gpm	WPD		HEATING - EAT 70°F							COOLING - EAT 80/67 °F																							
		PSI	FT	Airflow cfm	HC MBtu/h	Power kW	HE MBtu/h	LAT °F	COP	HWC MBtu/h	Airflow cfm	TC MBtu/h	SC MBtu/h	S/T Ratio	Power kW	HR MBtu/h	EER	HWC MBtu/h																
20	10.0	3.2	7.4	Operation not recommended							Operation not recommended																							
	13.0	5.1	11.9	Operation not recommended							Operation not recommended																							
	16.0	7.4	17.1	1400	35.9	3.53	23.9	93.8	2.98	5.9	1700	36.8	3.48	24.9	90.0	3.10	5.3																	
30	10.0	3.1	7.1	Operation not recommended							Operation not recommended																							
	13.0	5.0	11.6	1400	38.7	3.35	27.2	95.6	3.38	5.5	1400	55.6	38.6	0.69	1.72	61.5	32.4	-	1700	40.3	3.44	28.6	92.0	3.43	0.7	1700	56.5	42.2	0.75	1.81	62.7	31.2	-	
	16.0	7.2	16.6	1400	41.9	3.58	29.7	97.7	3.43	5.0	1400	55.9	38.6	0.69	1.67	61.6	33.6	-	1700	42.9	3.53	30.9	93.4	3.56	5.7	1700	57.3	42.2	0.74	1.75	63.3	32.7	-	
40	10.0	3.0	6.9	Operation not recommended							Operation not recommended																							
	13.0	4.8	11.2	1400	45.3	3.45	33.5	100.0	3.85	6.5	1400	59.6	40.3	0.68	1.92	66.2	31.0	-	1700	46.9	3.52	34.9	95.5	3.90	5.9	1700	60.7	44.0	0.72	2.02	67.6	30.1	-	
	16.0	7.0	16.1	1400	47.8	3.54	35.7	101.6	3.96	6.7	1400	60.1	40.3	0.67	1.86	66.4	32.2	-	1700	49.4	3.61	37.1	96.9	4.02	6.1	1700	61.4	44.0	0.72	1.95	68.1	31.5	-	
50	10.0	2.9	6.7	1400	50.1	3.55	38.0	103.1	4.13	6.8	1400	62.1	40.0	0.64	2.18	69.6	28.4	2.3	1700	51.7	3.60	39.4	98.1	4.21	6.3	1700	63.9	44.3	0.69	1.00	67.3	28.1	2.4	
	13.0	4.7	10.9	1400	51.9	3.55	39.7	104.3	4.28	7.0	1400	62.7	40.3	0.64	2.13	70.0	29.5	2.1	1700	53.4	3.60	41.1	99.1	4.35	6.4	1700	64.4	44.6	0.69	2.17	71.8	29.7	2.3	
	16.0	6.8	15.6	1400	54.3	3.64	41.9	105.9	4.38	7.2	1400	63.7	41.3	0.65	2.11	70.9	30.2	2.0	1700	55.9	3.68	43.3	100.4	4.45	6.6	1700	65.5	45.7	0.70	2.15	72.8	30.5	2.2	
60	10.0	2.8	6.5	1400	57.7	3.68	45.1	108.2	4.59	7.5	1400	59.3	39.2	0.66	2.52	68.0	23.5	3.2	1700	59.1	3.71	46.5	102.2	4.67	6.9	1700	61.0	43.4	0.71	2.57	69.8	23.7	3.4	
	13.0	4.5	10.5	1400	60.0	3.67	47.5	109.7	4.79	7.7	1400	59.9	39.4	0.66	2.46	68.3	24.3	3.0	1700	61.4	3.70	48.8	103.5	4.87	7.1	1700	61.5	43.6	0.71	2.51	70.1	24.5	3.2	
	16.0	6.6	15.1	1400	62.1	3.76	49.3	111.1	4.84	7.9	1400	60.9	40.4	0.66	2.44	69.2	25.0	2.8	1700	63.5	3.78	50.6	104.6	4.93	7.3	1700	62.6	44.8	0.72	2.49	71.0	25.2	3.1	
70	10.0	2.7	6.3	1400	65.3	3.81	52.3	113.2	5.02	8.3	1400	56.5	38.4	0.68	2.86	66.3	19.7	4.4	1700	68.1	3.85	55.0	107.1	5.18	7.7	1700	58.5	43.5	0.74	2.98	68.3	19.6	4.6	
	13.0	4.4	10.2	1400	68.1	3.80	55.2	115.1	5.26	8.5	1400	57.1	38.6	0.68	2.79	66.6	20.4	4.1	1700	69.4	3.79	56.4	107.8	5.36	7.9	1700	58.6	42.7	0.73	2.85	68.7	20.6	4.4	
	16.0	6.3	14.7	1400	69.9	3.88	56.7	116.2	5.28	8.8	1400	58.0	39.6	0.68	2.77	67.4	21.0	3.8	1700	71.1	3.87	57.9	108.7	5.38	8.1	1700	59.6	43.8	0.73	2.82	69.2	21.1	4.2	
80	10.0	2.6	6.1	1400	72.5	3.95	59.1	118.0	5.38	9.2	1400	54.3	37.3	0.69	3.30	65.5	16.4	6.2	1700	73.5	3.93	60.1	110.0	5.49	8.5	1700	55.8	41.2	0.74	3.37	67.3	16.6	6.6	
	13.0	4.3	9.8	1400	76.0	3.92	62.6	120.3	5.68	9.5	1400	54.8	37.5	0.68	3.22	65.7	17.0	5.8	1700	76.9	3.89	63.6	111.9	5.79	8.8	1700	56.3	41.5	0.74	3.28	67.5	17.2	6.3	
	16.0	6.1	14.2	1400	77.1	4.01	63.4	121.0	5.64	9.8	1400	55.7	38.4	0.69	3.19	66.5	17.5	5.4	1700	77.9	3.97	64.4	112.4	5.75	9.1	1700	57.2	42.6	0.74	3.25	68.3	17.6	6.0	
90	10.0	2.5	5.9	1400	79.8	4.09	65.9	122.8	5.72	10.3	1400	52.0	36.2	0.70	3.74	64.7	13.9	8.0	1700	80.5	4.04	66.7	113.8	5.84	9.5	1700	53.4	40.0	0.75	3.81	66.4	14.0	8.5	
	13.0	4.1	9.5	1400	84.0	4.05	70.1	125.5	6.07	10.6	1400	52.5	36.4	0.69	3.64	64.9	14.4	7.5	1700	84.5	4.00	70.8	116.0	6.19	9.8	1700	53.9	40.3	0.75	3.71	66.6	14.5	8.1	
	16.0	5.9	13.6	1400	84.3	4.14	70.2	125.8	5.98	11.0	1400	52.6	37.6	0.71	3.56	64.7	14.8	6.9	1700	84.7	4.07	70.8	116.1	6.10	10.2	1700	54.8	41.3	0.75	3.68	67.4	14.9	7.7	
100	10.0	2.4	5.6	Operation not recommended							Operation not recommended																							
	13.0	4.0	9.1	Operation not recommended							Operation not recommended																							
	16.0	5.7	13.2	1400	48.9	35.4	0.72	4.18	63.1	11.7	10.0	1400	50.2	39.2	0.78	4.26	64.7	11.8	10.9	1400	49.7	36.3	0.73	4.14	63.8	12.0	9.3	1700	51.1	40.2	0.79	4.22	65.4	12.1
110	10.0	2.3	5.4	Operation not recommended							Operation not recommended																							
	13.0	3.8	8.8	Operation not recommended							Operation not recommended																							
	16.0	5.5	12.7	1400	45.3	34.4	0.76	4.71	61.4	9.6	12.7	1400	46.5	38.1	0.82	4.80	62.9	9.7	13.8	1400	46.0	35.3	0.77	4.67	62.0	9.9	11.8	1700	47.3	39.1	0.83	4.76	63.5	9.9
120	10.0	2.3	5.2	Operation not recommended							Operation not recommended																							
	13.0	3.7	8.4	Operation not recommended							Operation not recommended																							
	16.0	5.3	12.2	1400	42.4	34.8	0.82	5.38	60.8	7.9	15.8	1400	43.2	37.8	0.88	5.52	62.0	7.8	17.1	1400	42.8	34.8	0.81	5.21	60.6	8.2	14.6	1700	43.7	37.8	0.86	5.37	62.0	8.1

Performance Data

072 Water Heating Data

ELT	EST	LGPM	SOURCE 12.0 GPM					SWPD		HWC kBtuh	SOURCE 15.0 GPM					SWPD		HWC kBtuh	SOURCE 18.0 GPM					SWPD		HWC kBtuh				
			LLT	HC	KW	HE	COP	LST	PSI		FT HD	LLT	HC	KW	HE	COP	LST		PSI	FT HD	LLT	HC	KW	HE	COP		LST	PSI	FT HD	
80	30	12.0	Operation Not Recommended																											
		15.0	87.7	54.7	3.89	42.5	4.4	22.7	4.4	10.2	7.6	87.8	55.6	3.97	43.6	4.4	23.8	6.8	15.7	7.8	88.0	56.6	4.06	44.7	4.5	24.9	9.2	21.3	8.0	
		18.0	86.0	54.5	3.89	42.7	4.4	22.7	4.4	10.2	7.4	86.2	55.5	3.98	43.7	4.5	23.8	6.9	15.9	7.4	86.3	56.4	4.06	44.7	4.5	24.9	9.4	21.7	7.4	
80	40	12.0	Operation Not Recommended																											
		15.0	88.9	63.2	3.93	50.9	5.0	31.3	4.3	9.9	8.8	89.1	64.5	4.01	52.3	5.0	32.6	6.6	15.3	9.0	89.3	65.7	4.10	53.6	5.1	33.9	9.0	20.7	9.2	
		18.0	87.0	63.1	3.92	51.1	5.0	31.3	4.3	9.9	8.5	87.2	64.4	4.01	52.4	5.1	32.6	6.7	15.5	8.6	87.4	65.6	4.09	53.7	5.2	33.9	9.1	21.0	8.6	
80	50	12.0	92.2	71.9	3.98	59.2	5.5	39.8	4.2	9.6	10.3	92.5	73.4	4.06	60.8	5.5	41.4	6.4	14.8	10.6	92.8	75.0	4.15	62.4	5.6	42.9	8.6	19.9	10.9	
		15.0	90.1	71.8	3.97	59.4	5.6	39.8	4.2	9.6	9.9	90.3	73.3	4.05	60.9	5.7	41.3	6.4	14.9	10.2	90.6	74.9	4.14	62.5	5.7	42.9	8.7	20.2	10.4	
		18.0	88.0	71.7	3.96	59.6	5.7	39.8	4.2	9.6	9.6	88.2	73.3	4.04	61.1	5.8	41.3	6.5	15.0	9.7	88.4	74.9	4.13	62.7	5.9	42.9	8.8	20.4	9.9	
80	60	12.0	93.6	80.4	4.02	67.6	6.0	48.4	4.0	9.3	11.5	94.0	82.2	4.11	69.4	6.1	50.1	6.2	14.4	11.8	94.3	84.1	4.20	71.3	6.3	51.9	8.4	19.5	12.1	
		15.0	91.3	80.3	4.01	67.8	6.2	48.4	4.0	9.3	11.1	91.6	82.2	4.09	69.6	6.3	50.1	6.3	14.5	11.3	91.9	84.1	4.18	71.4	6.4	51.9	8.5	19.6	11.6	
		18.0	89.0	80.2	3.99	68.0	6.3	48.4	4.0	9.3	10.7	89.2	82.2	4.07	69.8	6.4	50.1	6.3	14.5	10.9	89.5	84.1	4.16	71.6	6.5	51.8	8.5	19.7	11.1	
80	70	12.0	95.0	88.9	4.07	76.0	6.6	56.9	3.9	9.0	12.7	95.5	91.1	4.16	78.1	6.7	58.9	6.1	14.0	13.0	95.9	93.2	4.25	80.1	6.9	60.9	8.3	19.1	13.2	
		15.0	92.5	88.9	4.05	76.2	6.8	56.9	3.9	9.0	12.3	92.9	91.1	4.13	78.3	6.9	58.9	6.1	14.0	12.5	93.2	93.3	4.22	80.4	7.0	60.9	8.2	19.0	12.8	
		18.0	90.0	88.8	4.02	76.4	6.9	56.9	3.9	9.0	11.8	90.3	91.1	4.11	78.5	7.1	58.9	6.1	14.0	12.1	90.5	93.3	4.19	80.6	7.2	60.8	8.2	19.0	12.3	
100	30	12.0	Operation Not Recommended																											
		15.0	107.4	53.2	5.06	37.9	3.4	23.5	4.3	10.0	7.3	107.5	54.0	5.02	38.8	3.5	24.5	6.7	15.4	7.5	107.6	54.9	4.98	39.7	3.5	25.5	9.0	20.8	7.6	
		18.0	105.9	53.1	5.04	38.1	3.5	23.6	4.3	10.0	7.1	106.0	53.9	5.13	38.9	3.5	24.5	6.7	15.5	7.1	106.0	54.8	5.23	39.8	3.6	25.5	9.1	21.0	7.1	
100	40	12.0	Operation Not Recommended																											
		15.0	108.6	61.0	5.11	45.8	3.9	32.4	4.5	10.4	8.3	108.5	62.0	5.08	46.8	4.0	33.4	6.5	15.0	8.5	108.5	63.0	5.06	47.8	4.0	34.4	8.5	19.7	8.6	
		18.0	106.8	60.9	5.10	46.2	4.0	32.6	4.7	11.0	8.1	106.9	61.9	5.17	47.1	4.0	33.6	6.8	15.7	8.1	107.0	62.9	5.25	48.0	4.1	34.6	8.8	20.4	8.2	
100	50	12.0	111.6	68.8	5.17	53.3	4.3	40.8	4.1	9.5	9.7	111.2	69.9	5.08	54.4	4.4	41.8	5.8	13.4	9.9	110.8	71.0	5.00	55.5	4.4	42.8	7.5	17.3	10.1	
		15.0	109.7	68.8	5.17	53.8	4.4	41.3	4.6	10.7	9.4	109.6	69.9	5.15	54.8	4.4	42.3	6.3	14.6	9.5	109.4	71.1	5.13	55.9	4.5	43.2	8.0	18.6	9.7	
		18.0	107.8	68.8	5.17	54.3	4.4	41.7	5.1	11.9	9.1	107.9	69.9	5.22	55.3	4.5	42.7	6.9	15.9	9.1	108.0	71.1	5.27	56.3	4.6	43.7	8.6	19.9	9.2	
100	60	12.0	113.0	76.5	5.21	61.1	4.7	49.5	4.0	9.3	10.8	112.3	77.7	5.17	62.2	4.8	50.5	5.4	12.5	10.9	111.7	79.0	5.13	63.4	4.9	51.4	6.8	15.7	11.1	
		15.0	110.8	76.5	5.22	61.7	4.8	50.2	4.8	11.0	10.4	110.6	77.8	5.21	62.8	4.9	51.1	6.2	14.3	10.6	110.4	79.1	5.21	64.0	5.0	52.1	7.6	17.5	10.7	
		18.0	108.7	76.6	5.23	62.4	4.9	50.8	5.6	12.8	10.1	108.9	78.0	5.26	63.5	5.0	51.8	7.0	16.1	10.2	109.0	79.3	5.29	64.6	5.1	52.8	8.4	19.3	10.3	
100	70	12.0	114.3	84.2	5.25	68.9	5.2	58.2	3.9	9.0	11.9	113.4	85.6	5.26	70.1	5.3	59.1	5.0	11.5	12.0	112.5	87.0	5.26	71.3	5.4	60.1	6.1	14.0	12.1	
		15.0	112.0	84.3	5.27	69.7	5.3	59.0	4.9	11.4	11.5	111.6	85.8	5.28	70.9	5.4	60.0	6.0	13.9	11.6	111.3	87.2	5.28	72.1	5.5	61.0	7.1	16.4	11.7	
		18.0	109.6	84.5	5.30	70.5	5.4	59.9	6.0	13.8	11.1	109.8	86.0	5.30	71.7	5.5	60.9	7.0	16.3	11.2	110.1	87.5	5.31	72.9	5.6	61.9	8.1	18.8	11.4	
120	30	12.0	Operation Not Recommended																											
		15.0	127.2	51.8	6.23	33.3	2.5	24.4	4.3	9.9	7.0	127.2	52.5	6.07	34.0	2.5	25.2	6.5	15.1	7.1	127.2	53.2	5.91	34.7	2.6	26.1	8.8	20.2	7.2	
		18.0	125.8	51.6	6.18	33.5	2.6	24.4	4.3	9.9	6.7	125.8	52.4	6.29	34.2	2.6	25.3	6.5	15.0	6.8	125.7	53.1	6.39	34.8	2.6	26.1	8.8	20.2	6.8	
120	40	12.0	Operation Not Recommended																											
		15.0	128.3	58.8	6.30	40.8	2.8	33.6	4.7	10.9	7.9	128.0	59.5	6.16	41.4	2.9	34.2	6.4	14.7	8.0	127.7	60.2	6.02	42.0	2.9	34.8	8.1	18.6	8.1	
		18.0	126.7	58.7	6.28	41.3	2.9	34.0	5.2	12.0	7.6	126.7	59.5	6.34	41.8	2.9	34.7	6.9	15.9	7.7	126.7	60.3	6.40	42.4	3.0	35.3	8.6	19.8	7.7	
120	50	12.0	131.1	65.7	6.36	47.5	3.1	41.9	4.1	9.4	9.2	130.0	66.4	6.10	48.0	3.2	42.3	5.2	12.1	9.2	128.9	67.0	5.85	48.5	3.2	42.7	6.3	14.7	9.3	
		15.0	129.3	65.8	6.37	48.2	3.2	42.8	5.1	11.8	8.9	128.8	66.5	6.25	48.7	3.2	43.2	6.2	14.4	8.9	128.3	67.2	6.13	49.2	3.3	43.6	7.4	17.0	8.9	
		18.0	127.5	65.9	6.38	49.0	3.2	43.7	6.1	14.2	8.5	127.6	66.6	6.39	49.5	3.3	44.1	7.3	16.8	8.6	127.7	67.4	6.41	50.0	3.3	44.5	8.4	19.4	8.6	
120	60	12.0	132.4	72.6	6.39	54.6	3.4	50.6	4.0	9.2	10.2	130.7	73.2	6.23	55.0	3.5	50.8	4.6	10.5	10.1	129.0	73.9	6.06	55.5	3.6	51.0	5.1	11.8	10.1	
		15.0	130.4	72.8	6.43	55.7	3.5	52.0	5.5	12.8	9.8	129.6	73.5	6.33	56.1	3.6	52.1	6.1	14.1	9.8	128.8	74.2	6.24	56.5	3.6	52.3	6.7	15.4	9.8	
		18.0	128.4	73.0	6.47	56.8	3.5	53.3	7.1	16.3	9.4	128.5	73.8	6.44	57.1	3.6	53.5	7.6	17.7	9.5	128.6	74.6	6.41	57.5	3.7	53.7	8.2	19.0	9.5	
120	70	12.0	133.6	79.5	6.43	61.8	3.7	59.4	3.9	9.0	11.1	131.4	80.1	6.35	62.1	3.8	59.4	3.9	9.0	11.0	129.1	80.7	6.27	62.4	3.9	59.3	3.9	9.0	10.9	
		15.0	131.4	79.8	6.50	63.2	3.8	61.2	6.0	13.8	10.7	130.4	80.5	6.42	63.5	3.9	61.1	6.0	13.8	10.7	129.4	81.2	6.35	63.8	4.0	61.1	6.0	13.8	10.7	
		18.0	129.2	80.1	6.57	64.5	3.9	62.9	8.0	18.5	10.3	129.4	80.9	6.50	64.8	4.0	62.9	8.0	18.5	10.4	129.6	81.7	6.42	65.1	4.1	62.9	8.0	18.5	10.4	

*Water heating mode only allows high compressor capacity operation.

- ELT = entering load fluid temperature to heat pump
- LLT = leaving load fluid temperature from heat pump
- LGPM = load flow in gallons per minute
- LWPD = load coax water pressure drop
- EST = entering source fluid temperature to heat pump
- LST = leaving source fluid temperature from heat pump
- HWC = desuperheater capacity
- SWPD = source coax water pressure drop
- PSI = pressure drop in pounds per square inch
- FT HD = pressure drop in feet of head
- KW = kilowatts
- HE = heat extracted in BTUH
- HC = total heating capacity in BTUH
- COP = coefficient of performance [HC/(KW x 3.413)]

Service Parts List

Dual Capacity Vertical Units					
		036	048	060	072
Compressor	Compressor (YASKIE's)	34P751-01	34P753-01	34P755-01	34P756-01
	Run Capacitor	16P008D21CK	16P008D31CK	16P008D32CK	16P008D34CK
	Sound Jacket	92P504A16			
	Power Harness	11P781-01			
	Power Harness IntelliSatret	11P781-08			
	Solenoid Harness	11P782-02			
Motor & Blower	Blower Assembly	54S572-01N		54S571-01N	
	ECM Motor	14S573-01		14S572-01	
	Blower Module Assembly	PMK591		PMK589	
	Blower & Housing	53P501B01			
	ECM Harness	11P792-01			
	ECM Power Harness	11P585B03			
Refrigeration Components	Air Coil	61706-41	61715-41	61725-41	
	Source Coax copper	62I579-01	62I543-04		
	Load Coax copper	62P579-01	62P543-04		
	Source Coax cupronickel	62I579-02	62I543-03		
	Load Coax cupronickel	62P579-02	62P543-03		
	EEV	33P617-01			
	EEV Stepper Motor	33P617-04			
	Reversing Valve	33P503-05	33P526-05		
	Diverting Valve	33P503-05	33P526-05		
	Filter Drier	36P500B01	36P500B02		
	Refrigerant Charge Compensator	36P512-01			
	*Hot Water Generator	62P516-05	62P516-03		
	Check Valve	33P589B02	33P589B03		
Solenoid Valve	33P575-01				
HW Pump	Hyrdonic Load Pump	24P002A03			
Electrical	Contactora	13P521-01			
	Transformer (100VA)	15P531-01			
	3 Pole Power Block	12P503-06			
	2 Pole Screw Term. Block	12P500A01			
	ABC Control Board	17X553-43			
	AXB1 Control Board	17X597-30			
	AXB2 Control Board	17X597-31			
	ASB Sensor Board	17P559-01			
ASB Sensor	19P688-01				
Sensors & Safeties	Freeze Detection Thermistor	FP1RK01			
	HWL Thermistor	12P505-10			
	Pressure Transducer	35P558-02			
	High Pressure Switch	SKHPE600			
	Low Pressure Switch	SKLPE40			
Filter	Air filter	59P509-08	59P509-07	59P509-06	

*Hot Water Generator option does not include an internal pump. A DPK5 will need to be ordered separately for the pump kit.

Decommissioning

Before carrying out this procedure, it is essential that the technician is completely familiar with the equipment and all its detail. It is recommended good practice that all refrigerants are recovered safely. Prior to the task being carried out, an oil and refrigerant sample shall be taken in case analysis is required prior to re-use of recovered refrigerant. It is essential that electrical power is available before the task is commenced.

1. Become familiar with the equipment and its operation.
2. Isolate system electrically.
3. Before attempting the procedure, ensure that:
 - mechanical handling equipment is available, if required, for handling refrigerant cylinders;
 - all personal protective equipment is available and being used correctly;
 - the recovery process is supervised at all times by a competent person;
 - recovery equipment and cylinders conform to the appropriate standards.
4. Pump down refrigerant system, if possible.
5. If a vacuum is not possible, make a manifold so that refrigerant can be removed from various parts of the system.
6. Make sure that cylinder is situated on the scales before recovery takes place.
7. Start the recovery machine and operate in accordance with instructions.
8. Do not overfill cylinders (no more than 80 % volume liquid charge).
9. Do not exceed the maximum working pressure of the cylinder, even temporarily.
10. When the cylinders have been filled correctly and the process completed, make sure that the cylinders and the equipment are removed from site promptly and all isolation valves on the equipment are closed off.
11. Recovered refrigerant shall not be charged into another REFRIGERATING SYSTEM unless it has been cleaned and checked

Decommissioning - Unit Labeling Requirements

Equipment shall be labelled stating that it has been de-commissioned and emptied of refrigerant. The label shall be dated and signed. For appliances containing FLAMMABLE REFRIGERANTS, ensure that there are labels on the equipment stating the equipment contains FLAMMABLE REFRIGERANT.

Refrigerant Recovery

When removing refrigerant from a system, either for servicing or decommissioning, it is recommended good practice that all refrigerants are removed safely.

When transferring refrigerant into cylinders, ensure that only appropriate refrigerant recovery cylinders are employed. Ensure that the correct number of cylinders for holding the total system charge is available. All cylinders to be used are designated for the recovered refrigerant and labelled for that refrigerant (i.e. special cylinders for the recovery of refrigerant). Cylinders shall be complete with pressure-relief valve and associated shut-off valves in good working order. Empty recovery cylinders are evacuated and, if possible, cooled before recovery occurs.

The recovery equipment shall be in good working order with a set of instructions concerning the equipment that is at hand and shall be suitable for the recovery of the flammable refrigerant. If in doubt, the manufacturer should be consulted. In addition, a set of calibrated weighing scales shall be available and in good working order. Hoses shall be complete with leak-free disconnect couplings and in good condition.

The recovered refrigerant shall be processed according to local legislation in the correct recovery cylinder, and the relevant waste transfer note arranged. Do not mix refrigerants in recovery units and especially not in cylinders.

If compressors or compressor oils are to be removed, ensure that they have been evacuated to an acceptable level to make certain that flammable refrigerant does not remain within the lubricant. The compressor body shall not be heated by an open flame or other ignition sources to accelerate this process. When oil is drained from a system, it shall be carried out safely.

Refrigerant Removal and Evacuation

When breaking into the refrigerant circuit to make repairs – or for any other purpose conventional procedures shall be used. However, for flammable refrigerants it is important that best practice be followed, since flammability is a consideration. The following procedure shall be adhered to:

- safely remove refrigerant following local and national regulations;
- evacuate;
- purge the circuit with inert gas (optional for A2L);
- evacuate (optional for A2L);
- continuously flush or purge with inert gas when using flame to open circuit; and
- open the circuit.

The refrigerant charge shall be recovered into the correct recovery cylinders if venting is not allowed by local and national codes. For appliances containing flammable refrigerants, the system shall be purged with oxygen-free nitrogen to render the appliance safe for flammable refrigerants.

This process might need to be repeated several times. Compressed air or oxygen shall not be used for purging refrigerant systems. For appliances containing flammable refrigerants, refrigerants purging shall be achieved by breaking the vacuum in the system with oxygen-free nitrogen and continuing to fill until the working pressure is achieved, then venting to atmosphere, and finally pulling down to a vacuum (optional for A2L). This process shall be repeated until no refrigerant is within the system (optional for A2L). When the final oxygen-free nitrogen charge is used, the system shall be vented down to atmospheric pressure to enable work to take place. The outlet for the vacuum pump shall not be close to any potential ignition sources, and ventilation shall be available.

Charging procedures

In addition to conventional charging procedures, the following requirements shall be followed.

- Ensure that contamination of different refrigerants does not occur when using charging equipment.
- Hoses or lines shall be as short as possible to minimise the amount of refrigerant contained in them.
- Cylinders shall be kept in an appropriate position according to the instructions.
- Ensure that the REFRIGERATING SYSTEM is earthed prior to charging the system with refrigerant.
- Label the system when charging is complete (if not already).
- Extreme care shall be taken not to overfill the REFRIGERATING SYSTEM.

Prior to recharging the system, it shall be pressure-tested with the appropriate purging gas. The system shall be leak-tested on completion of charging but prior to commissioning. A follow up leak test shall be carried out prior to leaving the site.

Revision Guide

Pages:	Description:	Date:	By:
All	Document Creation	01 Sept, 2024	MA

GEOSMART ENERGY



1-975 Bleams Road, Kitchener, ON N2E 3Z5, Canada | o: 1.866.310.6690 | f: 1.866.533.3889

GEOSMARTENERGY.COM

Product: **PREMIUM Q**
Type: Geothermal Heat Pump with Water Heating for
Radiant Floor Applications
Size: 3-6 Ton Dual Capacity
Document Type: Operation & Maintenance
Ref. Number: OMW5-0017S
Revision Date: 10/2024
Revision Number: 1

